



RECORD THIS INFORMATION FOR FUTURE REFERENCE:

Model Number \_\_\_\_\_  
Serial Number \_\_\_\_\_  
Date Purchased \_\_\_\_\_  
Retailer / Qualified Installer \_\_\_\_\_

# INSTALLATION & OPERATING INSTRUCTIONS

## THE CABANA LIGHTWEIGHT RV DOME AWNING™

**MODELS**  
**747XXX1X.002 AND 747XXX1X.102**



Read these instructions carefully. These instructions **MUST** stay with this product.

**REVISION B**  
Form No. 3312855.012 09/16  
(French 3312906.013\_B)  
©2016 Dometic Corporation  
LaGrange, IN 46761

**USA**  
SERVICE OFFICE  
Dometic Corporation  
1120 North Main Street  
Elkhart, IN 46514

**CANADA**  
Dometic Corporation  
46 Zatonski, Unit 3  
Brantford, ON N3T 5L8  
CANADA

**SERVICE CENTER &  
DEALER LOCATIONS**  
**Please Visit:**  
[www.eDometic.com](http://www.eDometic.com)

# INTRODUCTION

This dome awning (hereinafter referred to as “awning,” or “product”) is designed and intended for use on RVs with straight sides. It is designed for lightweight RVs.

This awning can be installed by one person with brief help from additional personnel. Use these instructions to install the awning, to ensure correct function of product, and to operate your awning safely and correctly. Keep these instructions with your awning for future reference.

Dometic Corporation reserves the right to modify appearances and specifications without notice.

# TABLE OF CONTENTS

INTRODUCTION .....	2
DOCUMENT SYMBOLS .....	2
IMPORTANT SAFETY INSTRUCTIONS.....	3
A. Recognize Safety Information .....	3
B. Understand Signal Words.....	3
C. Supplemental Directives.....	3
D. General Safety Messages .....	3
GENERAL INFORMATION.....	4
A. Application .....	4
B. Required Tools.....	4
C. Included Hardware .....	4
SPECIFICATIONS.....	4
INSTALLATION .....	5
A. Prepare Hardware Assembly.....	5
B. Assemble Poles And Dome Awning: Flex Collapsible Pole (1) And Telescoping Aluminum Poles (3).....	5
C. Seal Dome Awning And Install Skirt (Models 747XXXXX.002) .....	6
D. Seal Dome Awning And Skirt (Models 747XXXXX.102).....	7
OPERATION.....	8
A. Set-Up Options Of Dome Awning .....	8
GENERAL CARE AND USE.....	8
A. Storage .....	8
B. Precautions.....	9
C. Vinyl Fabric Maintenance .....	9
APPENDIX A: DOMETIC WARRANTY .....	10

# DOCUMENT SYMBOLS



Indicates additional information that is **NOT** related to physical injury.



Indicates step-by-step instructions.

# IMPORTANT SAFETY INSTRUCTIONS

This manual has safety information and instructions to help you eliminate or reduce the risk of accidents and injuries.

## A. Recognize Safety Information



This is the safety alert symbol. It is used to alert you to potential physical injury hazards. Obey all safety messages that follow this symbol to avoid possible injury or death.

## B. Understand Signal Words

A signal word will identify safety messages and property damage messages, and will indicate the degree or level of hazard seriousness.

**WARNING** indicates a hazardous situation that, if **NOT** avoided, could result in death or serious injury.

**CAUTION** indicates a hazardous situation that, if **NOT** avoided, could result in minor or moderate injury.

**NOTICE** is used to address practices **NOT** related to physical injury.

## C. Supplemental Directives



Read and follow all safety information and instructions to avoid possible injury or death.

Read and understand these instructions before [installing / using / servicing / performing maintenance on] this product.

Incorrect [installation / operation / servicing / maintaining] of this product can lead to serious injury. Follow all instructions.

The installation **MUST** comply with all applicable local and national codes, including the latest edition of the following standards:

### U.S.A.



- ANSI/NFPA70, National Electrical Code (NEC)
- ANSI/NFPA 1192, Recreational Vehicles Code

### CANADA

- CSA C22.1, Parts I & II, Canadian Electrical Code
- CSA Z240 RV Series, Recreational Vehicles

## D. General Safety Messages

**WARNING** Failure to obey the following warnings could result in death or serious injury:

- This product **MUST** be [installed / serviced] by a qualified service technician.
- Do **NOT** modify this product in any way. Modification can be extremely hazardous.
- **IMPACT OR CRUSH HAZARD.** This product should be installed in a controlled environment (inside). Do **NOT** install product during windy conditions, or when wind is expected. Otherwise, product could move unpredictably, become unstable, and could [detach / bend / collapse].
- Frequently examine product for imbalance (uneven fit / sagging / loose parts); and signs of wear or damage to wiring (if applicable) and other critical parts. Do **NOT** use product if adjustments or repairs are necessary.
  -  Critical parts may include awning fabric, cables, arm assemblies, etc.
- Do **NOT** allow anyone (including children) with reduced physical, sensory or mental capabilities, or lack of experience and knowledge to use this product, unless they have been given supervision or instruction (concerning use of this product) by a person responsible for their safety.
- Do **NOT** allow children to play with product or with fixed controls (if applicable).
- **IMPACT OR CRUSH HAZARD. NEVER** leave an open awning unattended. Keep awning stowed (closed) when snow, heavy rain, wind, and severe weather conditions are expected. Failure to obey this warning could result in death or serious injury.
- **IMPACT OR CRUSH HAZARD.** Do **NOT** allow water to pool, snow to accumulate, or heavy debris on awning fabric. Do **NOT** hang or place anything on awning. The awning will become unstable, and could bend or collapse. Failure to obey this warning could result in death or serious injury.
- **FIRE HAZARD.** Keep sources of heat and fire (barbecue grills, portable heater, etc.) away from awning.
- **FIRE HAZARD.** Do **NOT** use sources of heat or fire (barbecue grills, portable heaters, camping stoves, gas burning lamps, etc.) inside dome awning.
- **CARBON MONOXIDE HAZARD.** Do **NOT** operate any internal combustion engine (generator, motorcycle, etc.) inside dome awning.
- **CAUTION** **PINCH HAZARD.** Maintain a horizontal distance of at least 16" between fully open awning and any permanent object. Failure to obey this caution could result in injury.
-  Do **NOT** face awning toward permanent objects that may interfere with awning operation.

# GENERAL INFORMATION

## A. Application

The Cabana Lightweight RV Dome Awning™ is designed for use on lightweight RVs, allowing users to nearly double their current living space. Product features and specifications as described or illustrated are subject to change without notice. Installation methods not described in this manual must have written permission from Dometic Corporation.

## B. Required Tools

- Silicone spray / Lubricant
- Power Drill / Screwdriver (models 747XXXXX.002 only)
- Polyurethane Sealant (models 747XXXXX.002 only)

## C. Included Hardware

- Dome Awning / Room
- (1) Flex Pole (collapsible)
- (3) Roof Poles (adjustable)
- (25) Tent Stakes
- (2) Hold Down Webbing Straps
- Mesh Vehicle Skirt
- (16) Snap Fast Fasteners (models 747XXXXX.002)
- (7) Suction Cups (models 747XXXXX.102)

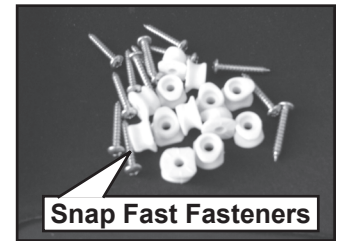
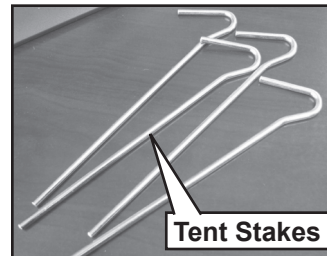
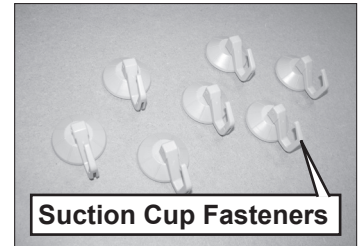
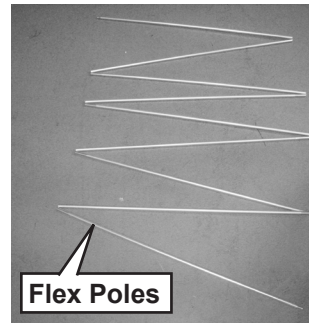
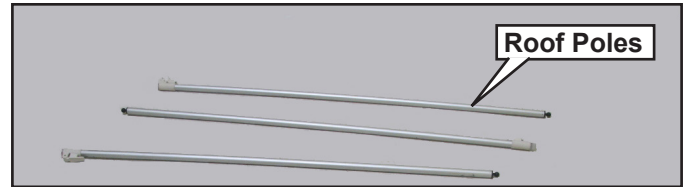

# SPECIFICATIONS

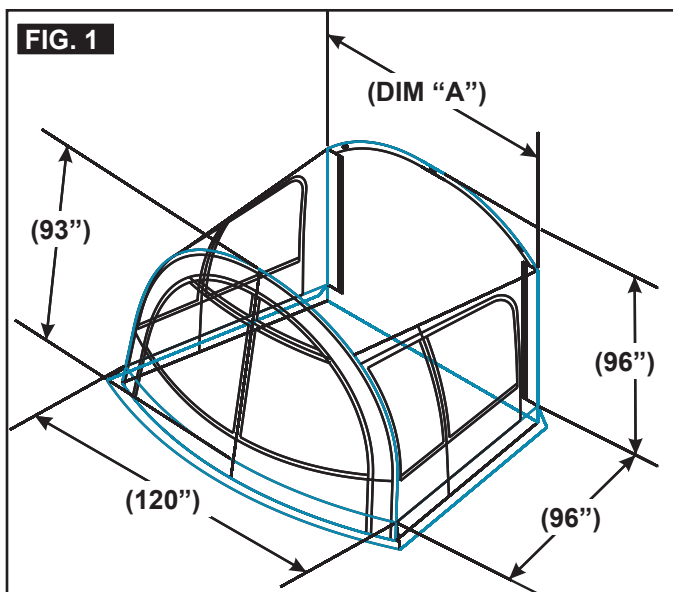

Model	Awning Size	Dim. "A" (Width)
747XXX10.X02	10'	120"
747XXX12.X02	12'	140"
747XXX13.X02	13'	156"
747XXX15.X02	15'	184"
747XXX16.X02	16'	192"



# INSTALLATION

## A. Prepare Hardware Assembly

1. Select the desired awning rail end (on RV) into which the awning fabric will be inserted. Widen that end of the rail with a flat screwdriver, and file off any sharp edges. See (FIG. 2).

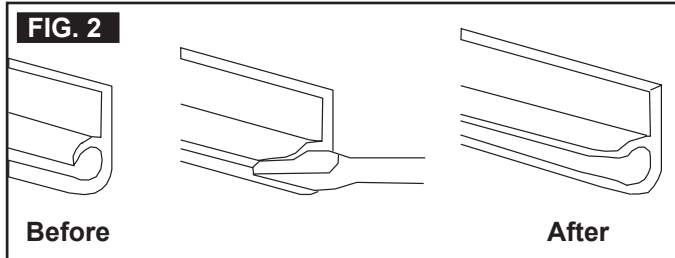

2. Spray inside of awning rail with silicone spray or lubricant to ease sliding Dome Awning and skirt through awning rails.
3. Carefully slide Dome Awning into awning rail until it is in the desired position.
4. Undo ties to roll fabric assembly out.

## B. Assemble Poles And Dome Awning: Flex Collapsible Pole (1) And Telescoping Aluminum Poles (3)

1. Assemble collapsible flex pole. Prepare Dome Awning for flex pole by unzipping front panel from the bottom up. Stop approximately at the buckles. Insert flex pole into sewn-in pocket located on front of Dome Awning. Push flex pole through entire front pocket.

 Do **NOT** try to pull flex pole through. Pulling will only disassemble sections of the flex pole.



2. When flex pole is pushed through entire front pocket, secure (1) pole end into brass grommet in webbing. See (FIG. 4) & (FIG. 5).

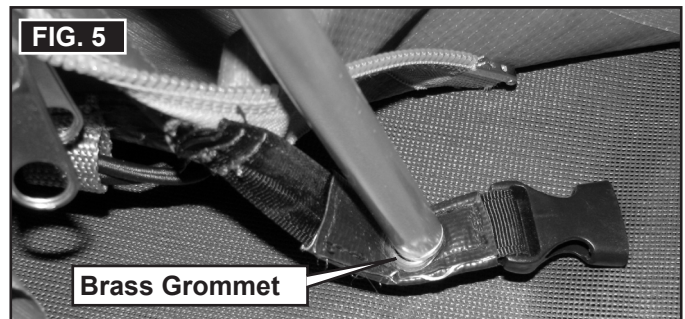
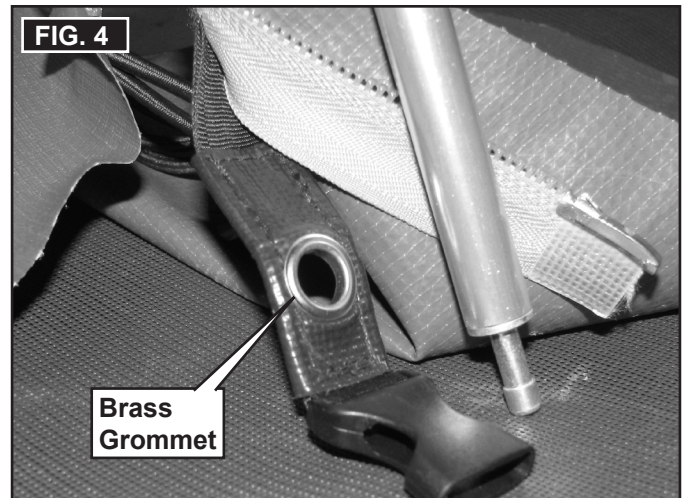

3. Buckle the webbing strap on the opposite side. See (FIG. 6).



4. Form arch with flex pole and insert other end of flex pole into brass grommet on webbing. Zip front panel to ease the next step. With someone's help, hold Dome Awning in place while telescoping aluminum roof poles are installed inside Dome Awning. See (FIG. 7).

# INSTALLATION

FIG. 7



5. Open lock on Clenchlock Lever System of telescoping aluminum roof poles. See (FIG. 8).

FIG. 8

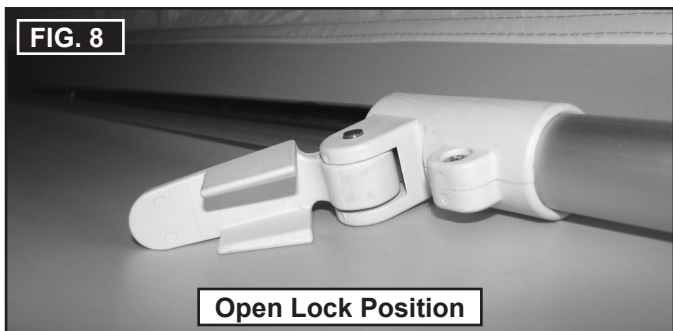

6. Insert ball end into ball end socket built into rear flap of Dome Awning assembly against RV wall as shown. See (FIG. 9).

FIG. 9

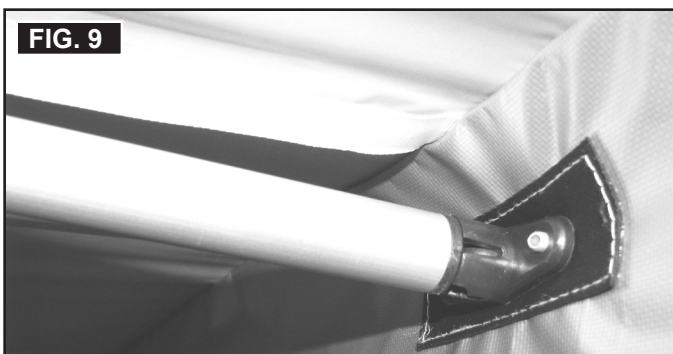

7. Hook opposite end of telescoping pole onto front flex pole through opening in fabric assembly. This operation is easier to do from outside of Dome Awning or with help from outside of Dome Awning. See (FIG. 10).

FIG. 10



8. Extend the telescoping pole to stretch roof fabric out and lock Clenchlock Lever in place. See (FIG. 11) & (FIG. 12).

FIG. 11

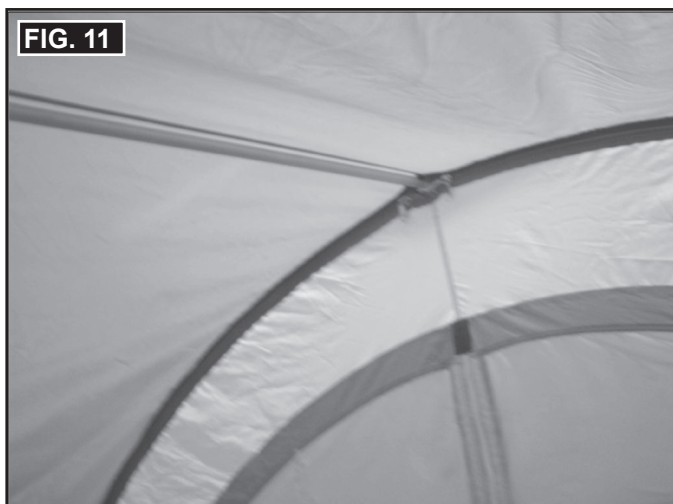
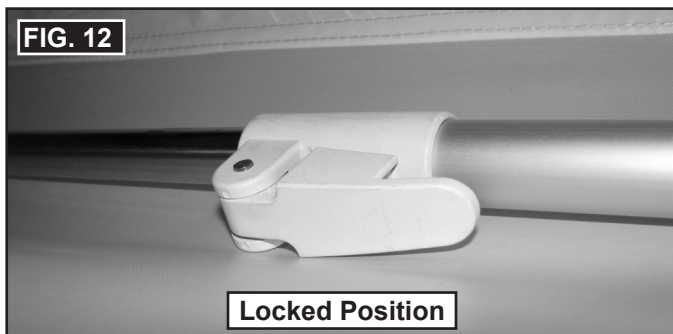

FIG. 12



9. Repeat above step for remaining (2) telescoping poles.

## C. Seal Dome Awning And Install Skirt (Models 747XXXXX.002)

1. Straighten out fabric and fold bottom flaps towards outside. See (FIG. 13).



# INSTALLATION



2. Once Dome Awning is in place, snap fast fasteners (included) should be installed and fastened to provide a seal between RV and Dome Awning.
  - a. Determine location of snap fast fasteners by pulling fabric flap against RV and marking location of grommet centers (3 on each side) on RV side wall.
  - b. Drill 1/8" pilot hole for installation of snap fast fasteners.

 You may drill hole right through fabric in center of grommets if desired.

- c. Apply polyurethane sealant to the back of fastener and threads of screw for fastener before screwing them to the side wall as they will remain on side wall for future use. Spare fasteners and screws have been provided for convenience. See (FIG. 14).



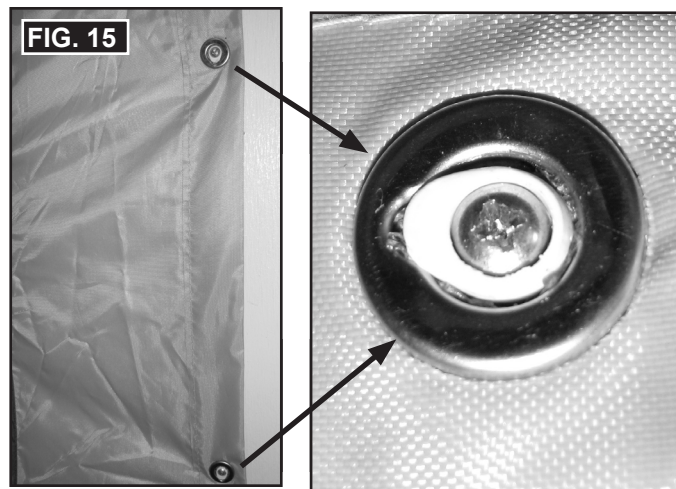

- d. Fasten snap fast fasteners by pressing on grommets to allow fastener through. See (FIG. 15).



3. Install Vehicle Skirt by sliding skirt through awning rail previously installed by manufacturer on RV. Cut mesh skirt where necessary to allow access to steps and go over RV axle.

## D. Seal Dome Awning And Skirt (Models 747XXXXX.102)

-  1. Straighten out fabric and fold bottom flaps towards outside. See (FIG. 13).
2. Once Dome Awning is in place, suction cup fasteners (included) should be installed and fastened to provide a seal between RV and Dome Awning.
  - a. Place hook on suction cup fastener through grommet (with hook facing out) and pull fabric flap against RV.
  - b. Once flap is in correct position against side wall, push suction cup, in unlocked position, onto RV.
  - c. Rotate hook to the locked position, securing suction cup fastener and fabric flap against wall.
  - d. Repeat steps (3 on each side) until fabric flap is fully secured.

 Spare suction cup has been provided for convenience.

3. Install Vehicle Skirt by sliding skirt through awning rail previously installed by manufacturer on RV. Cut mesh skirt where necessary to allow access to steps and go over RV axle.

# OPERATION

## A. Set-Up Options Of Dome Awning

1. Side door can be rolled up and tied for convenient entry and exit or it can be zipped shut for privacy and help prevent flying insects from entering.
2. Privacy panels on Dome Awning can be rolled up and tied in place with sewn-in ties to allow for air circulation and visibility.
3. Dome Awning can also be used as breezeway by unzipping and rolling up both sides. See (FIG. 16).



4. To use Dome Awning as a porch, unzip and roll up both sides and remove entire front panel.
  - a. To remove front panel, unzip panels from top center down.
5. Optional hold down straps are included with the Cabana Lightweight RV Dome Awning™ in case additional stability is required in windy conditions. Buckle one end to mating buckle attached to top of side panel on Dome Awning. See (FIG. 17). Secure opposite end of strap to ground with tent stake.

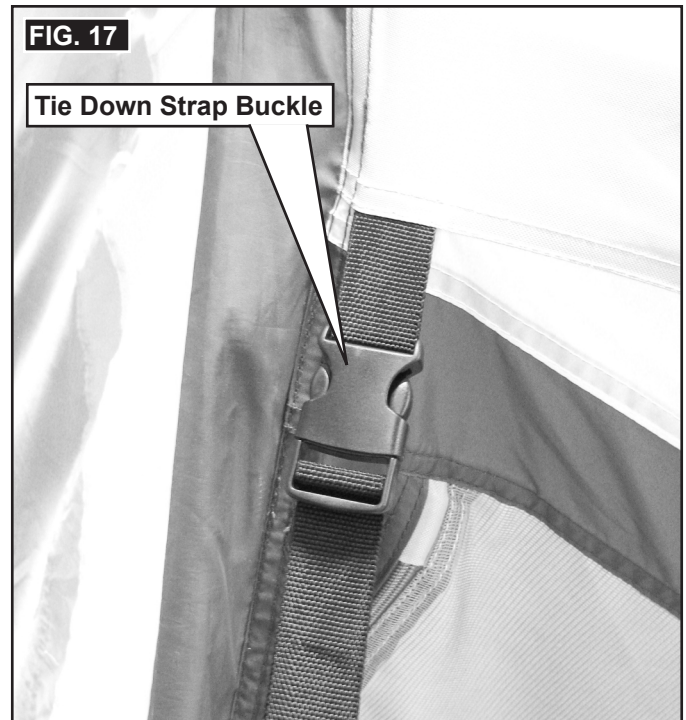

6. Elastic cord loops at the hem of Dome Awning provide extra stability when staked to ground with included tent stakes. See (FIG. 18).

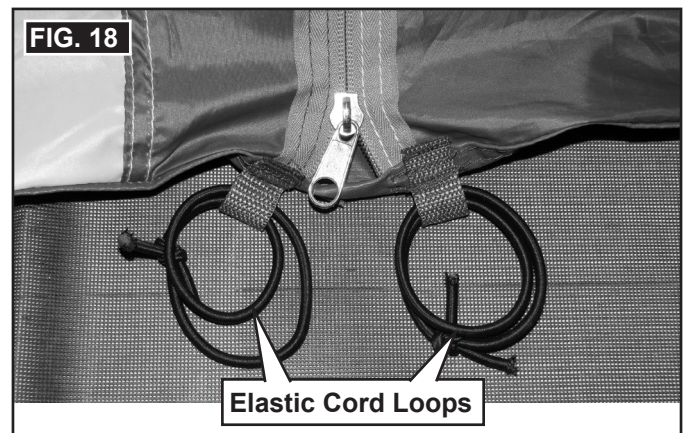

# GENERAL CARE AND USE

## A. Storage

1. Remove tent stakes, if any were installed, from hem and from hold down straps.
2. Unroll privacy panels and door and zip front panel, if it was previously removed. Leave front panel unzipped from bottom to buckle location.
3. Remove Vehicle Skirt from RV. Skirt can be folded and stored in the carry / storage bag.
4. Remove telescoping poles one at a time.
  - a. Unlock Clenchlock lever.
  - b. Unhook telescoping pole from front flex pole.
  - c. Pull opposite end of telescoping pole from ball end base on Dome Awning.
5. Set telescoping poles aside, as they will be stored in the bag with the Dome Awning and Skirt.
6. Remove flex pole from pocket on Dome Awning front.
  - a. Unbuckle webbing strap on bottom front.
  - b. Pull ends of flex pole out of brass grommet on webbing strap, one side at a time.

# GENERAL CARE AND USE

c. Push flex pole through pocket.



Do **NOT** try to pull flex pole through pocket. Pulling will only disassemble sections of the flex pole.

7. Collapse flex pole and set aside with telescoping poles for storage.
8. Once the Dome Awning fabric assembly is hanging without poles, slide the assembly out of the awning rail and lay on dry, flat, clean surface to fold for storage.
  - a. Fold side panels of fabric in towards center of fabric assembly so as to try to make a rectangle no wider than the length of the carry / storage bag provided.
9. Place all poles at the end of the fabric assembly, wrap fabric around poles and continue rolling up entire fabric assembly as tightly and neatly as possibly.
10. Place rolled Cabana Lightweight Dome Awning™ in carry / storage bag. Insert Skirt and bagged tent stakes into bag and zip closed.

## B. Precautions

**NOTICE** Failure to obey the following notices could damage product or property:

- Do **NOT** use insecticides or other sprays near awning fabric. These could cause stains, and could adversely affect fabric's ability to repel water.
- Do **NOT** expose awning to adverse environmental conditions, corrosive agents, or other harmful conditions.
- Do **NOT** allow dirt, leaves, or other debris to accumulate on awning, which could cause abrasion and stains. Mildew could grow on dirt and organic debris causing permanent discoloration, stains, and odors to awning fabric.

## C. Vinyl Fabric Maintenance

Vinyl fabric offers the advantage of durability and water resistance.



Wrinkling is a normal characteristic of vinyl. Wrinkling may be more noticeable after prolonged periods of stowage (rolled up). Leave awning open during warm weather to minimize the wrinkling over a period of time.

1. To clean:



- a. Mix 1/4 cup dish soap and 1/4 cup bleach to 5 gallons of fresh water to use as cleaning solution.
- b. **NOTICE** Do **NOT** use abrasive or corrosive cleaners, mildew removers, or hard bristle brushes on awning fabric.  
Liberally drench open awning fabric with cleaning solution.

c. Close awning, let it soak for 5 minutes, then open awning again.

d. **NOTICE** Remove solution **COMPLETELY** from awning fabric. Bleach will degrade awning fabric if **NOT** completely rinsed off.

Thoroughly hose off top and bottom of fabric with clean water.



Repeat as necessary to completely remove solution.

e. **NOTICE** **NEVER** close awning (for storage) when wet. The combination of moisture and dirt could result in mildew, discoloration, and stains.

Allow awning to dry thoroughly before stowing (rolling up).



If it is necessary to roll up awning (temporarily) while it is wet, make sure to roll it out and let it dry (as soon as conditions allow) before rolling it up again.

2. To repair a pinhole, or if a spot of coating flakes off from top layer of vinyl fabric:



a. Apply a very small dab of VLP (Vinyl Liquid Patch) on tip of cotton swab.



VLP is available from Dometic Corporation. Reference part number 3314216.000 when ordering.

b. Gently roll cotton swab around pinhole. The VLP will melt the coating (on fabric) and that will quickly fill in pinhole and blend with all colored vinyls.

c. **NOTICE** **NEVER** close (roll up) awning when vinyl liquid patch is wet. Otherwise, damage to other parts of awning fabric (melting through layers) will occur.

Allow VLP to dry thoroughly before stowing (rolling up) awning.



# APPENDIX A: DOMETIC WARRANTY

Dometic's exclusive one (1) year warranty is included along with important maintenance information. Please take a few moments to familiarize yourself with our warranty and maintenance program. We truly appreciate your business, and we are confident you will enjoy many years of trouble-free RV use.

## **LIMITED ONE-YEAR WARRANTY THE SELLER NAMED BELOW MAKES THE FOLLOWING WARRANTY WITH RESPECT TO THE DOMETIC PRODUCT:**

1. This Warranty is made only to the first purchaser (hereinafter referred to as the "Original Purchaser") who acquires the product for his own use and is installed and operated within the continental United States and Canada.
2. This Warranty will be in effect for one (1) year from the date of purchase by the original purchaser. It is suggested that the original purchaser retain a copy of the dated bill of sale as evidence of the date of purchase.
3. This Warranty covers only specified parts which shall be free from defects in material and workmanship under normal use. This warranty does NOT cover conditions unrelated to the material and workmanship of the product. Such unrelated conditions include, but are not limited to: (a) damage not reported within seven (7) days of ownership; (b) failure or damage caused by storms, rain, water pooling, or any acts of God; (c) faulty installation and any damage resulting from such; (d) the need for normal maintenance and any damage resulting from the failure to provide such maintenance; (e) failure to follow Sellers instructions for use of this product; (f) any accident to or misuse of any part of this product and any alteration by anyone other than the Seller or its authorized representative; (g) damage or failure caused by installation of accessories not manufactured and marketed by the Seller; and (h) normal wear and product abuse.
4. The specified parts covered by this warranty, where applicable, are as follows: (a) Roller tube against rust, corrosion and extrusion defects; (b) Fabric free from quality defects (normal wear is not covered); (c) Screen assemblies free from quality defects (normal wear is not covered); (d) Torsion assemblies, including motor-driven assemblies, against extrusion defects, electrical faults, or breakage; and (d) Hardware against extrusion defects.
5. In order to obtain the benefits of this warranty, you should return the product which you find defective to the Seller named below or to a Dometic Authorized Service Center during the period that this warranty is in effect. The original owner is responsible for all charges incurred in delivery of the product to the Seller, or Dometic Authorized Service Center, and in pick up after the warranty service has been completed. To obtain the location of the nearest Authorized Service Center, please call 1-800-544-4881.
6. Any item returned in the manner described in paragraph 5 will be examined by the Seller or the Authorized Dometic Service Center. If it is found that the returned item was defective in material and workmanship, the Seller or the Authorized Dometic Service Center will repair the product per the terms of this one (1) year limited warranty without charge for material or labor during the first year of ownership by the original purchaser. Confirm the service agency is an Authorized Dometic Service Center. DO NOT pay the service agency for Warranty repairs. Such payments will not be reimbursed.
7. Dometic Corporation will pay freight on replacement parts during the first ninety (90) days of ownership by the original purchaser.
8. The Seller does not authorize any person or company to create any warranty obligations or liability on their behalf. This warranty is not extended by the length of time which you are deprived of the use of the product. Repairs and replacement parts provided under the terms of this warranty shall carry only the non-expired portion of this warranty.
9. In no event shall either Seller be liable for incidental or consequential damages. This includes any damage to another product or products resulting from such a defect. Some states do not allow the exclusion or limitation of incidental or consequential damages, so the above limitations may not apply.
10. Any implied warranty, including the implied warranty of merchantability and fitness for any purpose, is limited to the duration of this limited warranty. Some states do not allow limitations on how long an implied warranty can last, so the above limitation may not apply.
11. THIS WARRANTY GIVES YOU SPECIFIC LEGAL RIGHTS, YOU MAY ALSO HAVE OTHER RIGHTS WHICH VARY FROM STATE TO STATE. No action to enforce this warranty shall be commenced later than ninety (90) days after the expiration of the warranty period. Claims must be submitted in writing to the Dometic Warranty Department for arbitration.
12. All products (except those specifically built for commercial use) are warranted only when installed on vehicles built to R.V.I.A. and C.R.V.A., Z-240 Standards.
13. The Seller reserves the right to change the design of any product without notice and with no obligation to make corresponding changes in products previously manufactured.

### **DOMETIC CORPORATION**

Warranty Department  
1120 North Main Street  
Elkhart, IN 46514