

# SKYSOL2 Shape 06 - Pointnose & Obtuse Edge

## Order Form and Product Guide

Customer \_\_\_\_\_  
 Address \_\_\_\_\_  
 \_\_\_\_\_

Tel \_\_\_\_\_  
 Mobile \_\_\_\_\_  
 Email \_\_\_\_\_

Order \_\_\_\_\_ Quote \_\_\_\_\_ Date \_\_\_\_\_  
 Project Name \_\_\_\_\_  
 Project Location \_\_\_\_\_

1 Blind No.	2 Window Location	3 Fabric	4 Blind or Recess	5 Hardware Colour	6 Blind Type	7 2 Bar or 3 Bar	8 3 Bar Cord Quick Tensioners <sup>1</sup>	9 Stack Position	10 Fixing position / Reference <sup>2,3</sup>		11 Manual control options		12 Powered options	13 Qty
									Top Of Blind	Bottom Of Blind	Pull Cord Position	Handle Type		
			Blind Recess	Beige White Graphite	AB (0° - 30°) DB (31° - 60°)  Enter precise incline in box below	<b>3 Bar only on this shape</b>	Yes No  <b>Manual Blinds only</b>	<b>Top Stack only on this shape</b>	Face fix Manual - HR3 Powered - XL3  Recess fix Manual - HR1 Powered - XL1	FR2C  FR1	<b>Not available on this shape</b>	None Webbing <sup>3</sup> Plastic Articulating <sup>3</sup> Plastic Fixed <sup>3</sup> Metal Chrome Metal Nickel Clear (Control Rod) Rod Length _____ Qty _____	Motor Position Top Bottom Motor Wire exit point Left Right Centre Controlled By Switch constant Switch Momentary Somfy remote <sup>4</sup> Dometic remote <sup>4</sup> Motor ID _____	

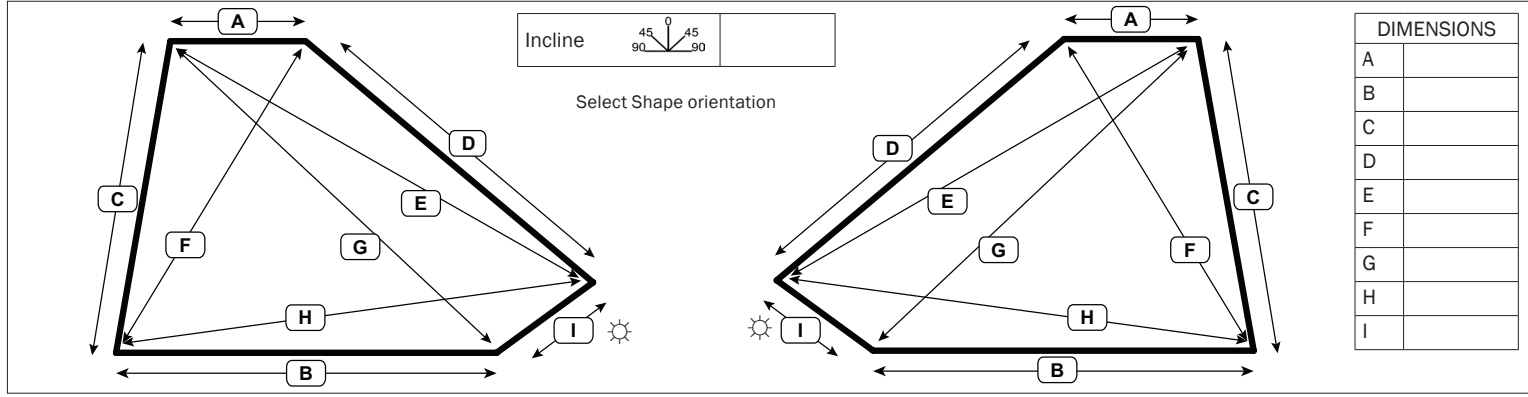

DIMENSIONS	
A	
B	
C	
D	
E	
F	
G	
H	
I	

Motor ID	Description	Voltage
25SD1	Atlantic 12S Double End	12 V DC
25SD2	Atlantic 24S Double End	24 V DC
24	Somfy LW25-B83	24 V DC
LV25	Somfy LV25-B64	24 V DC
TM24	Hunter Douglas M35S	24 V DC

- Quick Tensioners are fitted to the guide wires on all 3 bar blinds and optional on cords.
- See Manual Fixing Configurations on [page 2](#) and Powered Fixing Configurations on [page 3](#).
- Colour matched to hardware colour.
- Please fill in a Powered Accessories Custom Order Form.

☀ **Acute Edge Recess Deductions**  
 Powered 5mm [3/16"]  
 Manual 5mm [3/16"]

Additional requirements.



# SKYSOL2 Shape 06 - Pointnose & Obtuse Edge

## Order Form and Product Guide

### Manual Fixing Configurations

#### Recess Fix

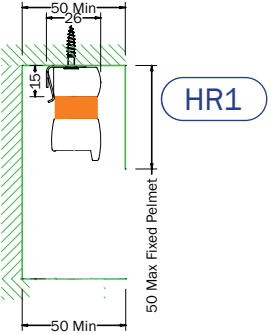

**2 BAR RECESS FIXED**  
BLIND Type:  
AO

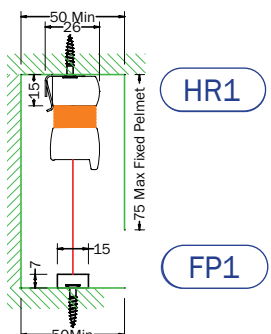

**2 BAR FOOTPLATE RECESS FIXED**  
BLIND Types:  
AO-DB, AO-DBE,  
AB, DB, DBE, PB

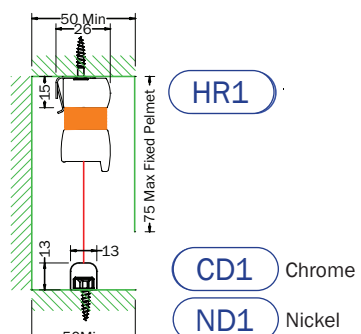

**2 BAR DOME RECESS FIXED**  
BLIND Types:  
AO-DB, AO-DBE,  
AB, DB, DBE, PB

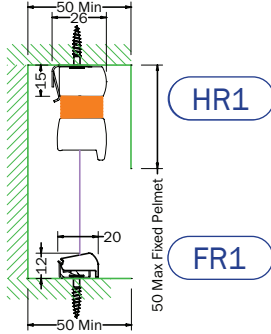

**3 BAR RECESS FIXED**  
BLIND Types:  
AO-DB, AO-DBE,  
AB, DB, DBE, PB

#### Face Fix

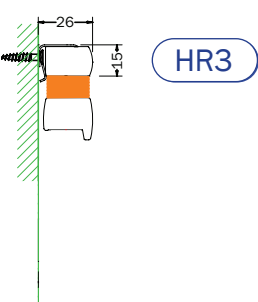

**2 BAR FACE FIXED**  
BLIND Type:  
AO

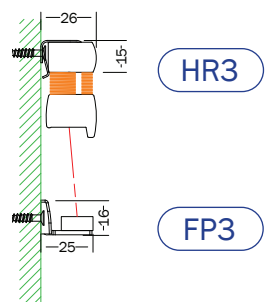

**2 BAR FOOTPLATE FACE FIXED**  
BLIND Types:  
AO-DB, AO-DBE,  
AB, DB, DBE, PB

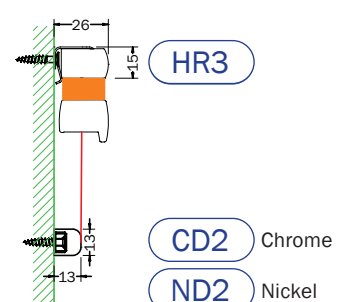

**2 BAR DOME FACE FIXED**  
BLIND Types:  
AO-DB, AO-DBE,  
AB, DB, DBE, PB

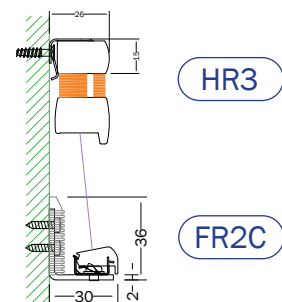

**3 BAR FACE FIXED**  
BLIND Types:  
AO-DB, AO-DBE,  
AB, DB, DBE, PB

# SKYSOL2 Shape 06 - Pointnose & Obtuse Edge

## Order Form and Product Guide

### Powered Fixing Configurations

#### Recess Fix

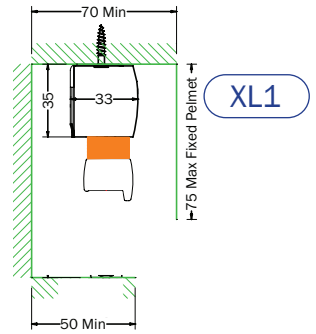

**2 BAR RECESS FIXED**  
BLIND Type:  
A0

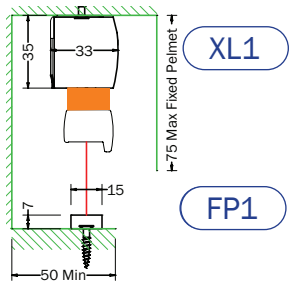

**2 BAR FOOTPLATE RECESS FIXED**  
BLIND Types:  
A0-DB, A0-DBE

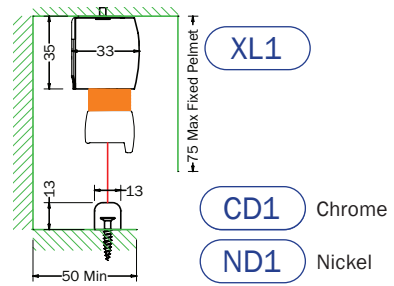

**2 BAR DOME RECESS FIXED**  
BLIND Types:  
A0-DB, A0-DBE

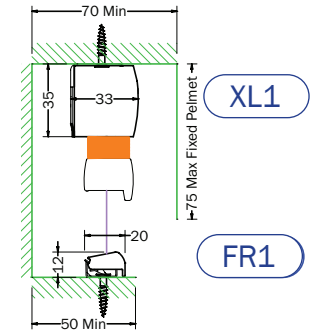

**3 BAR RECESS FIXED**  
BLIND Types:  
A0-DB, A0-DBE,  
AB, DB, DBE, PB

#### Face Fix

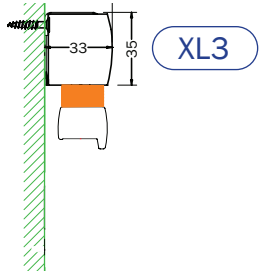

**2 BAR FACE FIXED**  
BLIND Type:  
A0

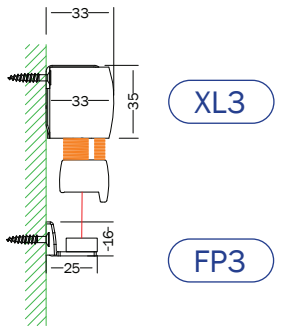

**2 BAR FOOTPLATE FACE FIXED**  
BLIND Types:  
A0-DB, A0-DBE

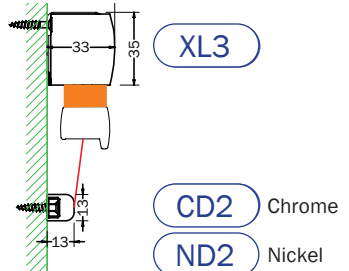

**2 BAR DOME FACE FIXED**  
BLIND Types:  
A0-DB, A0-DBE

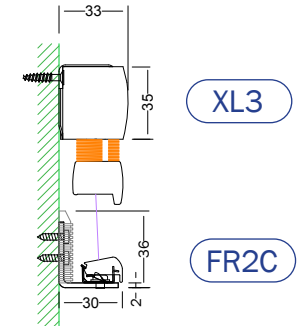

**3 Bar FACE FIXED**  
BLIND Types:  
A0-DB, A0-DBE,  
AB, DB, DBE, PB