

SKYSOL2 Shape 08 - Single Sided Pointnose

Order Form and Product Guide

Customer _____
 Address _____

Tel _____
 Mobile _____
 Email _____

Order _____ Quote _____ Date _____
 Project Name _____
 Project Location _____

1	2	3	4	5	6	7	8	9	10		11		12	13
Blind No.	Window Location	Fabric	Blind or Recess	Hardware Colour	Blind Type	2 Bar or 3 Bar	3 Bar Cord Quick Tensioners ¹	Stack Position	Fixing position / Reference ^{2,3}		Manual control options		Powered options	Qty
									Top Of Blind	Bottom Of Blind	Pull Cord Position	Handle Type		
			Blind Recess	Beige White Graphite	AB (0° - 30°) DB (31° - 60°) Enter precise incline in box below	3 Bar only on this shape	Manual Blinds only	Top Stack only	Face fix Manual - HR3 Powered - XL3	FR2C	Not available on this shape	None Webbing ³ Plastic Articulating ³ Plastic Fixed ³ Metal Chrome Metal Nickel Clear (Control Rod) Rod Length _____ Qty _____	Motor Position Top Bottom Motor Wire exit point Left Right Centre Controlled By Switch constant Switch Momentary Somfy remote ⁴ Dometic remote ⁴ Motor ID _____	
								Recess fix Manual - HR1 Powered - XL1	FR1					

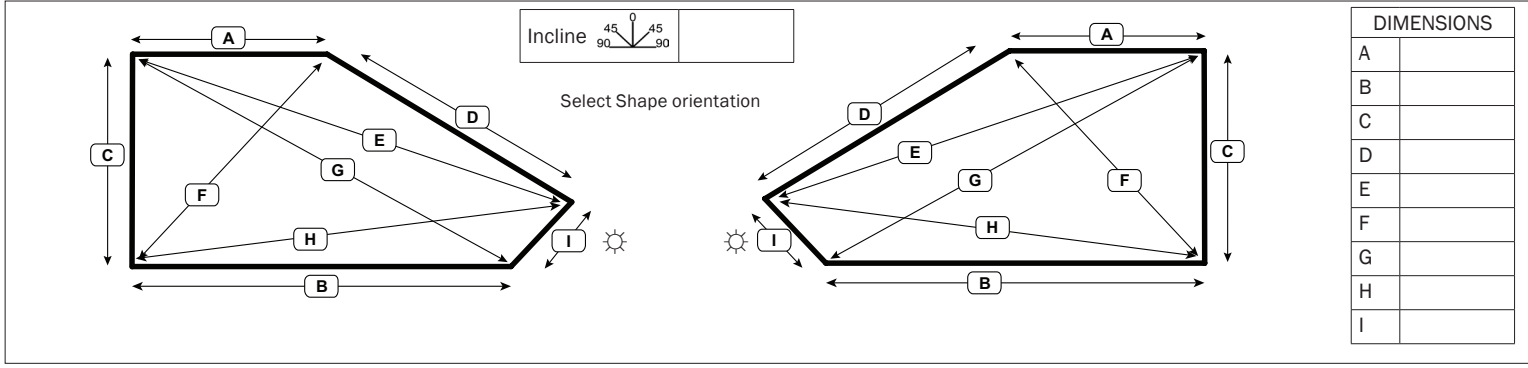

DIMENSIONS	
A	
B	
C	
D	
E	
F	
G	
H	
I	

Motor ID	Description	Voltage
25SD1	Atlantic 12S Double End	12 V DC
25SD2	Atlantic 24S Double End	24 V DC
24	Somfy LW25-B83	24 V DC
LV25	Somfy LV25-B64	24 V DC
TM24	Hunter Douglas M35S	24 V DC

1. Quick Tensioners are fitted to the guide wires on all 3 bar blinds and optional on cords.
2. See Manual Fixing Configurations on [page 2](#) and Powered Fixing Configurations on [page 3](#).
3. Colour matched to hardware colour.
4. Please fill in a Powered Accessories Custom Order Form.

☀ **Acute Edge Recess Deductions**
 Powered 5mm [3/16"]
 Manual 5mm [3/16"]

Additional requirements.



SKYSOL2 Shape 08 - Single Sided Pointnose

Order Form and Product Guide

Manual Fixing Configurations

Recess Fix

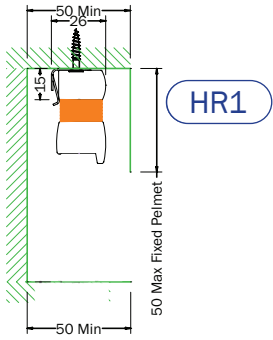

2 BAR RECESS FIXED
BLIND Type:
AO

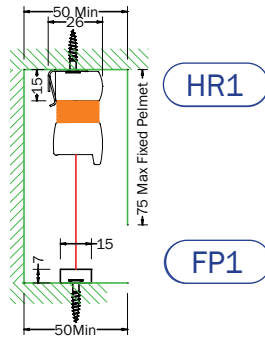

2 BAR FOOTPLATE RECESS FIXED
BLIND Types:
AO-DB, AO-DBE,
AB, DB, DBE, PB

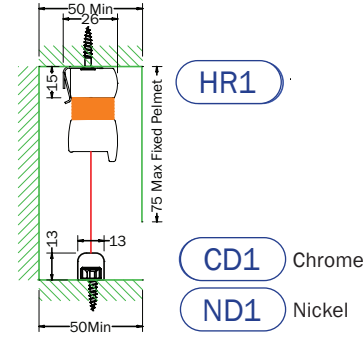

2 BAR DOME RECESS FIXED
BLIND Types:
AO-DB, AO-DBE,
AB, DB, DBE, PB

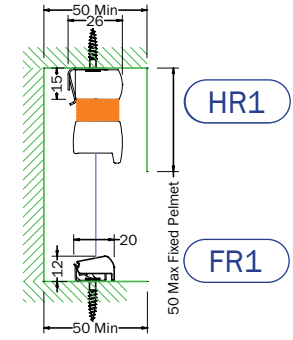

3 BAR RECESS FIXED
BLIND Types:
AO-DB, AO-DBE,
AB, DB, DBE, PB

Face Fix

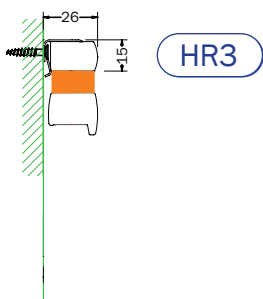

2 BAR FACE FIXED
BLIND Type:
AO

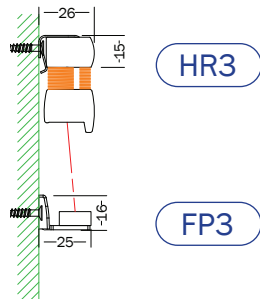

2 BAR FOOTPLATE FACE FIXED
BLIND Types:
AO-DB, AO-DBE,
AB, DB, DBE, PB

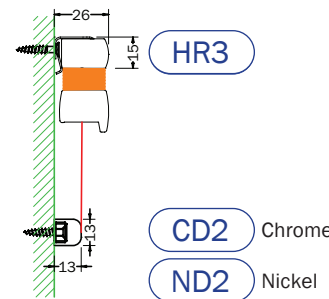

2 BAR DOME FACE FIXED
BLIND Types:
AO-DB, AO-DBE,
AB, DB, DBE, PB

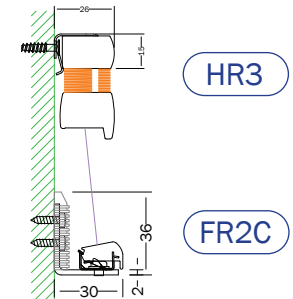

3 BAR FACE FIXED
BLIND Types:
AO-DB, AO-DBE,
AB, DB, DBE, PB

SKYSOL2 Shape 08 - Single Sided Pointnose

Order Form and Product Guide

Powered Fixing Configurations

Recess Fix

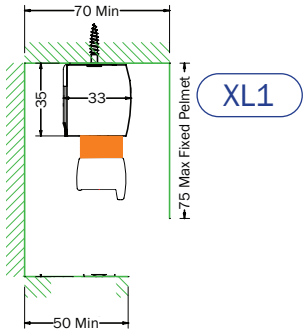

2 BAR RECESS FIXED
BLIND Type:
A0

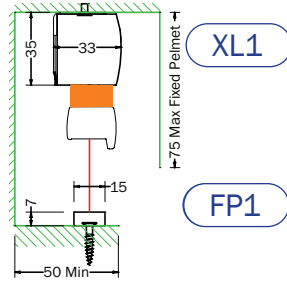

2 BAR FOOTPLATE RECESS FIXED
BLIND Types:
A0-DB, A0-DBE,

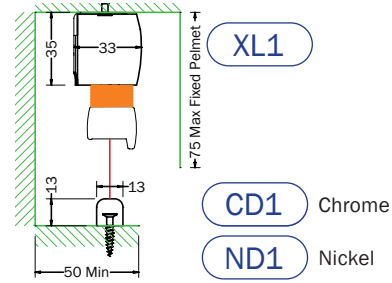

2 BAR DOME RECESS FIXED
BLIND Types:
A0-DB, A0-DBE,

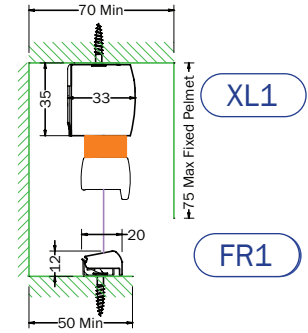

3 BAR RECESS FIXED
BLIND Types:
A0-DB, A0-DBE,
AB, DB, DBE, PB

Face Fix

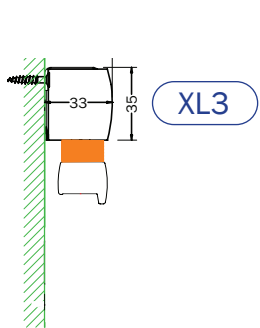

2 BAR FACE FIXED
BLIND Type:
A0

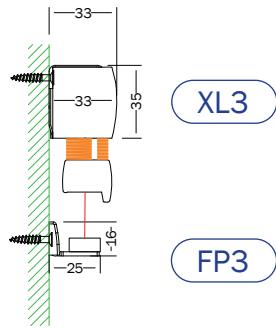

2 BAR FOOTPLATE FACE FIXED
BLIND Types:
A0-DB, A0-DBE,

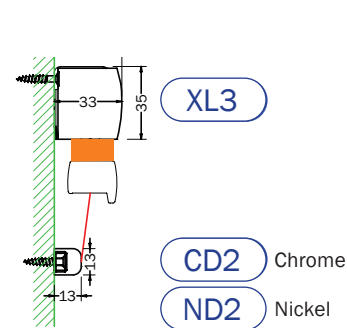

2 BAR DOME FACE FIXED
BLIND Types:
A0-DB, A0-DBE,

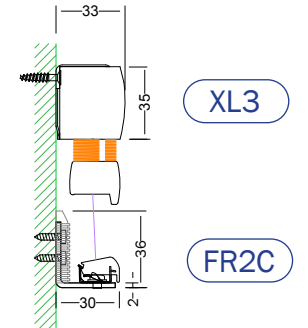

3 Bar FACE FIXED
BLIND Types:
A0-DB, A0-DBE,
AB, DB, DBE, PB