

SKYSOL2 Shape 10 - Low Acute Edge

Order Form and Product Guide

Customer _____ Tel _____ Order _____ Quote _____ Date _____
 Address _____ Mobile _____ Project Name _____
 _____ Email _____ Project Location _____

Disclaimer: **Are any of the blinds on this order to be installed where children under 42 months old are likely to be allowed?** **Yes** **No** **Signed** _____

1	2	3	4	5	6	7	8	9	10	11	12	13		
Blind No.	Window Location	Fabric	Blind or Recess	Hardware Colour	Blind Type	2 Bar or 3 Bar	3 Bar Cord Quick Tensioners ²	Stack Position	Fixing position / Reference ^{3,4}		Manual control options		Powered options	Qty
									Top Of Blind	Bottom Of Blind	Pull Cord Position	Handle Type		
			Blind Recess	Beige White Graphite	AO (0°) AO-DB (0° - 20°) † AO-DBE (0° - 20°) AB (0° - 30°) DB (31° - 60°) DBE (20° - 45°) PB (61° - 120°) Enter precise incline in box below	AO type blinds are 2 Bar only		Top Stack only on this shape	Face fix Manual - HR3 Powered - XL3	FR2C FP3 CD2 ND2	AO Blind Types only If an "AO" type blind is selected, a pull cord will be factory fitted on the longest vertical edge (Dim 'C' or 'D'). No other control is available. Metal Cord Cleat <i>(With black or white rubber insert)</i> Chrome - Black Chrome - White Nickel - Black Nickel - White	None Webbing ⁴⁺⁵ Plastic Articulating ⁴ Plastic Fixed ⁴ Metal Chrome Metal Nickel Clear (Control Rod) Rod Length _____ Qty _____	Motor Position Top Bottom Motor Wire exit point Left Right Center Controlled By Switch constant Switch Momentary Somfy remote ⁶ Dometic remote ⁶ Motor ID _____	
						2 Bar 3 Bar	Yes No			Recess fix Manual - HR1 Powered - XL1		FR1 FP1 CD1 ND1		

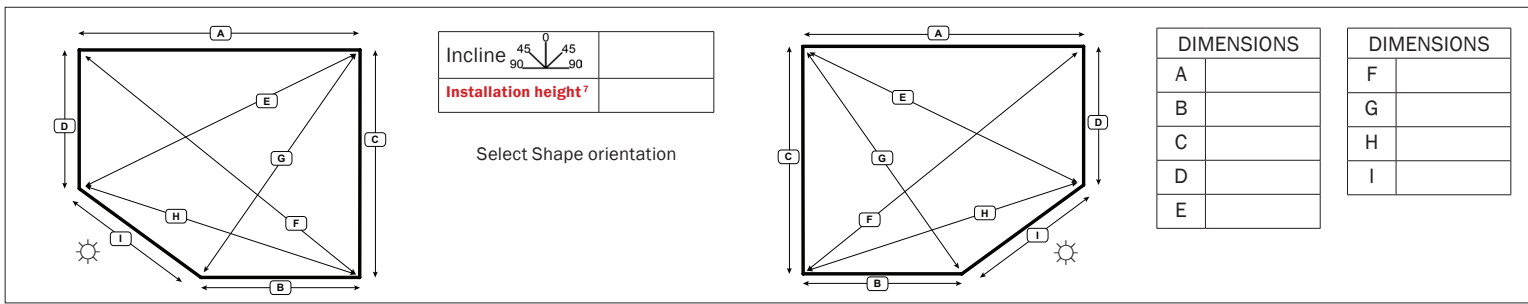

Motor ID	Description	Voltage
25SD1	Atlantic 12S Double End	12 V DC
25SD2	Atlantic 24S Double End	24 V DC
24	Somfy LW25-B83	24 V DC
LV25	Somfy LV25-B64	24 V DC
TM24	Hunter Douglas M35S	24 V DC

⚠ Acute Edge Recess Deductions
 Powered 5mm [3/16"]
 Manual 5mm [3/16"]

1. Guide wires run behind fabric.
2. Quick Tensioners are fitted to the guide wires on all 3 bar blinds.
Quick Tensioners are optional on cords (for easier tensioning)
3. Fixing Configurations: **Manual** - page 2, **Powered** - page 3.
4. Colour matched to hardware colour.
5. Webbing handles cannot be fitted to connect rails if one is required.
6. Please fill in a Powered Accessories Custom Order Form.

7. Installation height required for cord operated blinds.
EN13120 Standards demand the distance from the floor to the bottom of the pull cord(s) shall be at least 1500mm [59 1/16"] and a cord collection device (cleat) is fitted at or above this height.
We can only supply blinds meeting these conditions unless the above disclaimer is completed and signed.

Additional requirements.



SKYSOL2 Shape 10 - Low Acute Edge

Order Form and Product Guide

Manual Fixing Configurations

Recess Fix

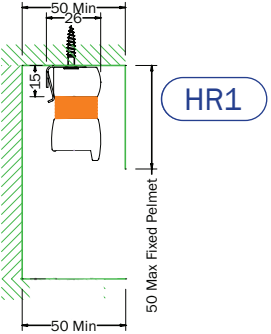

2 BAR RECESS FIXED
BLIND Type:
AO

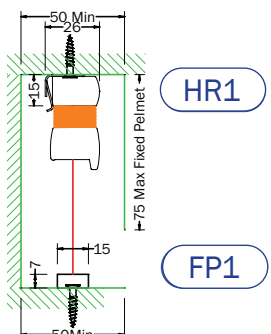

2 BAR FOOTPLATE RECESS FIXED
BLIND Types:
AO-DB, AO-DBE,
AB, DB, DBE, PB

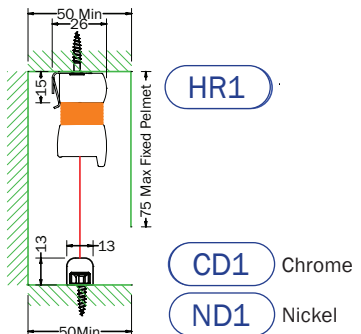

2 BAR DOME RECESS FIXED
BLIND Types:
AO-DB, AO-DBE,
AB, DB, DBE, PB

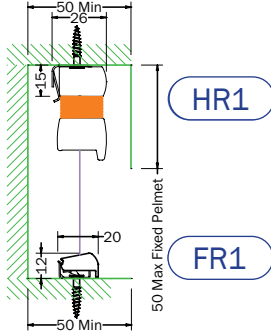

3 BAR RECESS FIXED
BLIND Types:
AO-DB, AO-DBE,
AB, DB, DBE, PB

Face Fix

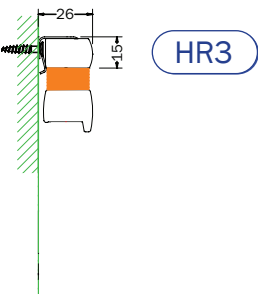

2 BAR FACE FIXED
BLIND Type:
AO

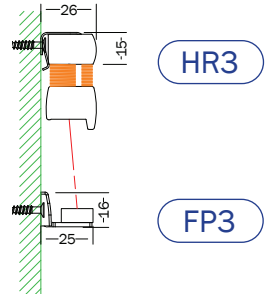

2 BAR FOOTPLATE FACE FIXED
BLIND Types:
AO-DB, AO-DBE,
AB, DB, DBE, PB

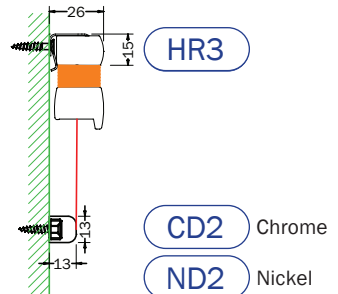

2 BAR DOME FACE FIXED
BLIND Types:
AO-DB, AO-DBE,
AB, DB, DBE, PB

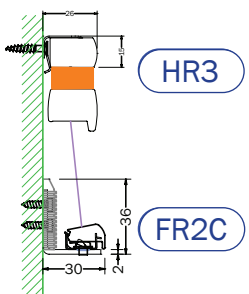

3 BAR FACE FIXED
BLIND Types:
AO-DB, AO-DBE,
AB, DB, DBE, PB

SKYSOL2 Shape 10 - Low Acute Edge

Order Form and Product Guide

Powered Fixing Configurations

Recess Fix

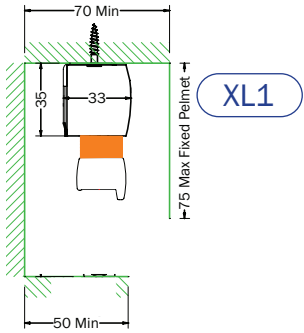

XL1

2 BAR RECESS FIXED
BLIND Type:
A0

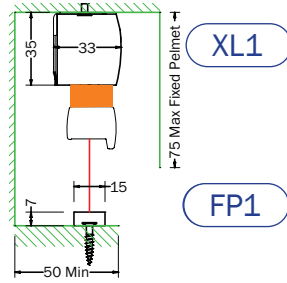

XL1

FP1

2 BAR FOOTPLATE RECESS FIXED
BLIND Types:
A0-DB, A0-DBE,

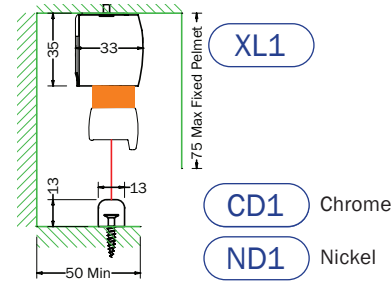

XL1

CD1

Chrome

ND1

Nickel

2 BAR DOME RECESS FIXED
BLIND Types:
A0-DB, A0-DBE,

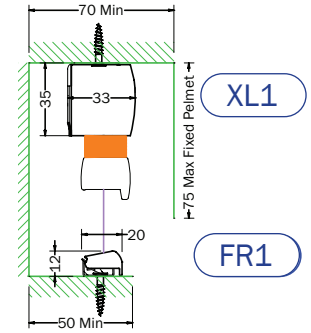

XL1

FR1

3 BAR RECESS FIXED
BLIND Types:
A0-DB, A0-DBE,
AB, DB, DBE, PB

Face Fix

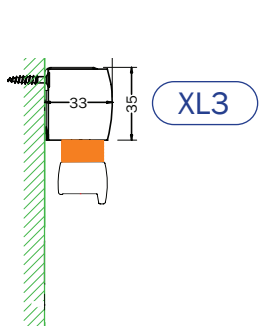

XL3

2 BAR FACE FIXED
BLIND Type:
A0

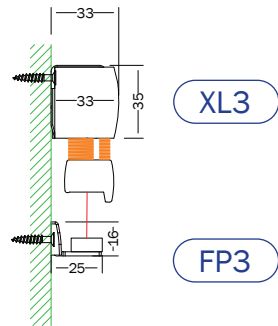

XL3

FP3

2 BAR FOOTPLATE FACE FIXED
BLIND Types:
A0-DB, A0-DBE,

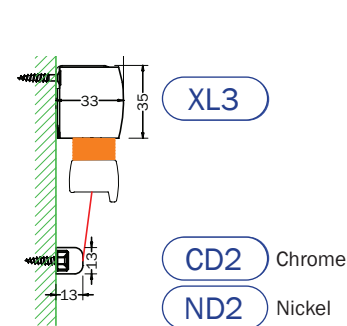

XL3

CD2

Chrome

ND2

Nickel

2 BAR DOME FACE FIXED
BLIND Types:
A0-DB, A0-DBE,

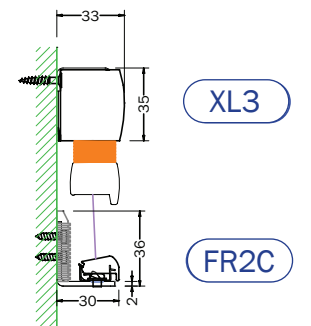

XL3

FR2C

3 Bar FACE FIXED
BLIND Types:
A0-DB, A0-DBE,
AB, DB, DBE, PB