

# SKYSOL2 Shape 16 - Rectangle with sloped bottom edge

## Order Form and Product Guide

Customer \_\_\_\_\_ Tel \_\_\_\_\_ Order \_\_\_\_\_ Quote \_\_\_\_\_ Date \_\_\_\_\_  
 Address \_\_\_\_\_ Mobile \_\_\_\_\_ Project Name \_\_\_\_\_  
 \_\_\_\_\_ Email \_\_\_\_\_ Project Location \_\_\_\_\_

Disclaimer: **Are any of the blinds on this order to be installed where children under 42 months old are likely to be allowed?**<sup>5</sup> **Yes No Signed** \_\_\_\_\_ **Print** \_\_\_\_\_

1	2	3	4	5	6	7	8	9	10		11		12	13	
Blind No.	Window Location	Fabric	Blind or Recess	Hardware Colour	Blind Type	2 Bar or 3 Bar		3 Bar Cord Quick Tensioners <sup>2</sup>	Stack Position	Fixing position / Reference <sup>3,4</sup>		Manual control options		Powered options	Qty
						2 Bar	3 Bar			Top Of Blind	Bottom Of Blind	Pull Cord Position	Handle Type		
			Blind Recess	Beige White Graphite	AO (0°) AO-DB (0°- 20°) <sup>1</sup> AO-DBE (0°- 20°) AB (0°- 30°) DB (31°- 60°) DBE (21°- 45°) PB (61°- 120°)  Enter precise incline in box below	<b>AO type blinds are 2 Bar only</b>		Yes No	Top Bottom	<b>Face fix</b> HR3	FR2C FP3 CD2 ND2	<b>AO Blind Types only</b> If an "AO" type blind is selected, a pull cord will be factory fitted on the longest vertical edge (Dim 'C' or 'D'). No other control is available. <b>Metal Cord Cleat</b> <i>(With black or white rubber insert)</i> <b>Chrome</b> - Black <b>Chrome</b> - White <b>Nickel</b> - Black <b>Nickel</b> - White	<b>AB, DB, DBE &amp; PB Blinds Only</b> None Webbing <sup>4</sup> Plastic Articulating <sup>4</sup> Plastic Fixed <sup>4</sup> Metal Chrome Metal Nickel Clear (Control Rod)  Rod Length _____ Qty _____	<b>Not available on this shape</b>	

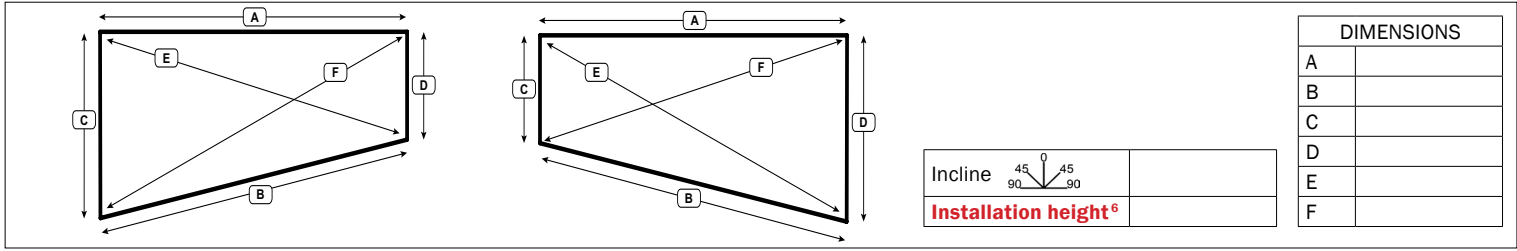

1. Guide wires run behind fabric.
2. Quick Tensioners are fitted to the guide wires on all 3 bar blinds. Quick Tensioners are optional on cords for easier tensioning.
3. See Manual Fixing Configurations on [page 2](#).
4. Colour matched to hardware.
5. Installation height required for cord operated blinds (AO, AO-DB, AO-DBE). EN13120 Standards demand the distance from the floor to the bottom of the pull cord(s) shall be at least 1500mm [59 1/16"] and a cord collection device (cleat) is fitted at or above this height. We can only supply blinds meeting these conditions unless the above disclaimer is completed and signed.

Additional requirements.



# SKYSOL2 Shape 16 - Rectangle with sloped bottom edge

## Order Form and Product Guide

### Manual Fixing Configurations

#### Recess Fix

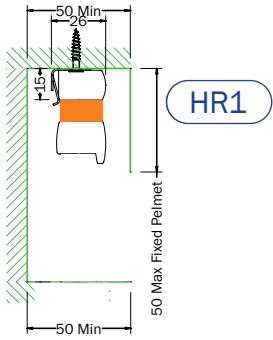

**2 BAR RECESS FIXED**  
BLIND Type:  
AO

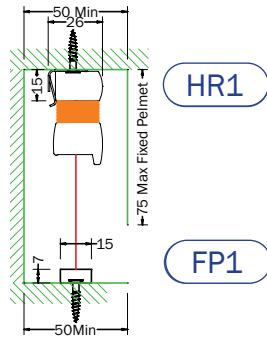

**2 BAR FOOTPLATE RECESS FIXED**  
BLIND Types:  
AO-DB, AO-DBE,  
AB, DB, DBE, PB

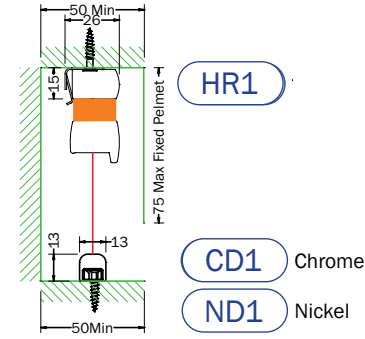

**2 BAR DOME RECESS FIXED**  
BLIND Types:  
AO-DB, AO-DBE,  
AB, DB, DBE, PB

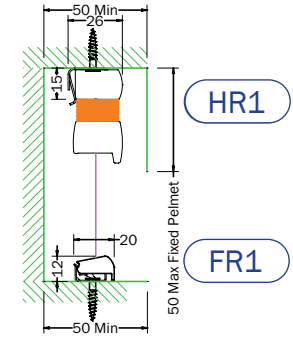

**3 BAR RECESS FIXED**  
BLIND Types:  
AO-DB, AO-DBE,  
AB, DB, DBE, PB

#### Face Fix

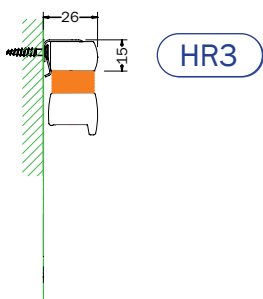

**2 BAR FACE FIXED**  
BLIND Type:  
AO

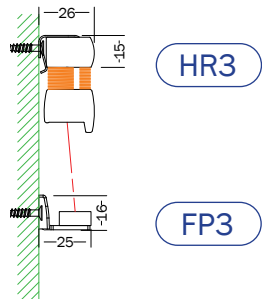

**2 BAR FOOTPLATE FACE FIXED**  
BLIND Types:  
AO-DB, AO-DBE,  
AB, DB, DBE, PB

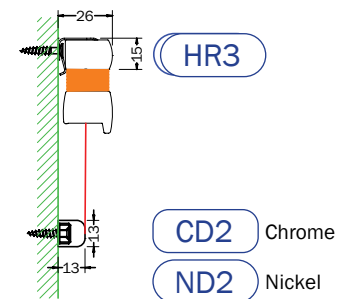

**2 BAR DOME FACE FIXED**  
BLIND Types:  
AO-DB, AO-DBE,  
AB, DB, DBE, PB

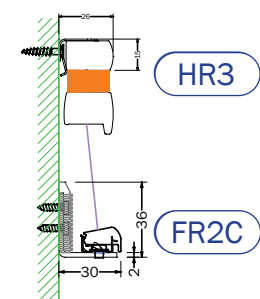

**3 BAR FACE FIXED**  
BLIND Types:  
AO-DB, AO-DBE,  
AB, DB, DBE, PB