

↗ DOMETIC

MARINE

CONTROL UNITS

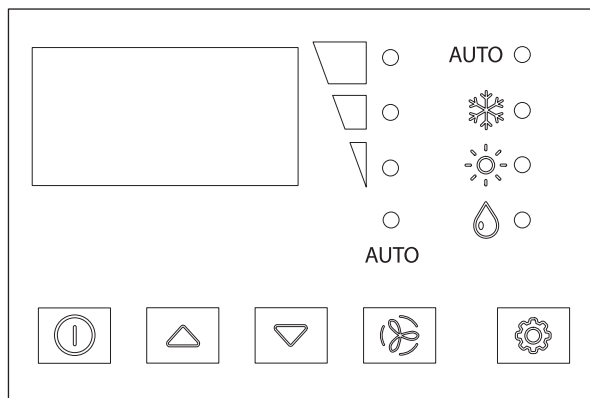

Elite Control Series

EN

Elite Control

Installation and Operating Manual 2

⚠ WARNING

Cancer and Reproductive Harm
www.P65Warnings.ca.gov

Copyright

© 2023 Dometic Group. The visual appearance of the contents of this manual is protected by copyright and design law. The underlying technical design and the products contained herein may be protected by design, patent or be patent pending. The trademarks mentioned in this manual belong to Dometic Sweden AB. All rights are reserved.

Service center & dealer locations

Visit: www.dometic.com

Please read these instructions carefully and follow all instructions, guidelines, and warnings included in this product manual in order to ensure that you install, use, and maintain the product properly at all times. These instructions **MUST** stay with this product.

By using the product, you hereby confirm that you have read all instructions, guidelines, and warnings carefully and that you understand and agree to abide by the terms and conditions as set forth herein. You agree to use this product only for the intended purpose and application and in accordance with the instructions, guidelines, and warnings as set forth in this product manual as well as in accordance with all applicable laws and regulations. A failure to read and follow the instructions and warnings set forth herein may result in an injury to yourself and others, damage to your product, or damage to other property in the vicinity. This product manual, including the instructions, guidelines, and warnings, and related documentation, may be subject to changes and updates. For up-to-date product information, please visit www.dometic.com.

Contents

1 Explanation of symbols and safety instructions	3
1.1 Recognize safety information	3
1.2 Understand signal words	3
1.3 Supplemental directives	4
1.4 General safety messages	4
2 Intended use	4
3 General information	4
3.1 Tools and materials	4
3.2 Display features	5
4 Specifications	5
4.1 Product dimensions	5
4.2 Cable length	6
4.3 Available system inputs	6
4.4 Operational specifications	6
5 Wiring Diagrams	7
6 Installation	9
6.1 Choosing a display panel location	9
6.2 Preparing the wall	9
6.3 Installing an optional sensor	9

6.4 Mounting the display panel	10
6.5 Testing the display	10

7 Operation	10
7.1 Understanding the heating and cooling cycles	11
7.2 Choosing the control operation	12
7.3 Using the control display panel	14
7.4 Programming the control	15
7.5 Navigation tree	25
8 Troubleshooting	26
9 Disposal	31
10 Warranty Information	31

1 Explanation of symbols and safety instructions

This manual has safety information and instructions to help you eliminate or reduce the risk of accidents and injuries.

1.1 Recognize safety information

 **This is the safety alert symbol.** It is used to alert you to potential physical injury hazards. Obey all safety messages that follow this symbol to avoid possible injury or death.

1.2 Understand signal words

A signal word will identify safety messages and property damage messages, and also will indicate the degree or level of hazard seriousness.

WARNING

Indicates a hazardous situation that, if **not** avoided, could result in death or serious injury.

NOTICE: Used to address practices **not** related to physical injury.

 Indicates additional information that is **not** related to physical injury.

1.3 Supplemental directives

To reduce the risk of accidents and injuries, please observe the following directives before proceeding to install or operate this appliance:

- Read and follow all safety information and instructions.
- Read and understand these instructions before installing and operating this product.
- The installation must comply with all applicable local or national codes, including the latest edition of the following standards:
 - ANSI/NFPA70, National Electrical Code (NEC)
 - American Boat and Yacht Council (ABYC)

1.4 General safety messages

⚠ WARNING: ELECTRICAL SHOCK, FIRE, AND/OR EXPLOSION HAZARD. Failure to obey the following warnings could result in death or serious injury:

- Use only Dometic replacement parts and components that are specifically approved for use with the appliance.
- Avoid improper installation, adjustment, alteration, service, or maintenance of the appliance. Service and maintenance must be done by a qualified service person only.
- Do **not** modify this product in any way. Modification can be extremely hazardous.
- This product should be installed in a controlled, indoor environment.

2 Intended use

The Elite Control is a user-friendly 5-volt logic and micro controller-based unit designed for use with direct expansion (DX), reverse-cycle air-conditioning systems, and chilled-water systems (CW). The 5 button display panel has 33 programmable parameters, automatic and manual fan speeds, standard and optional sensor inputs, and fits both Vimar® Idea and Eikon switch bezels.

This manual provides all necessary information for the proper installation and operation of the Elite Control display panel. Poor installation and misunderstood operating parameters will result in unsatisfactory performance and possible failure. The manufacturer accepts no liability for damage in the following cases:

- Faulty assembly or connection
- Damage to the product resulting from mechanical influences and excess voltage
- Alterations to the product without express permission from the manufacturer
- Use for purposes other than those described in the operating manual

Dometic Corporation reserves the right to modify appearances and specifications without notice.

3 General information

This section provides information on the tooling, parts, and display features for the Elite Control.

i The images used in this document are for reference purposes only. Components and component locations may vary according to specific product models. Measurements may vary ± 0.38 in. (10 mm).

The Elite Control models have the same features, installation procedure, and functionality.

3.1 Tools and materials

Dometic recommends that the following tools and materials be used while installing the appliance:

Recommended tools	
Phillips-head screwdriver	Saw
Safety glasses	

Included parts	Quantity
Screws	4
Elite Control	1

Additional parts ¹	DX	CW
Required for CW installations (not included)		
Water inlet temperature sensor		X
Optional parts		
Outside air temperature (OAT) sensor	X	X
Inside air temperature sensor	X	X
Auxiliary electric heater ²	X	X
Room temperature/relative humidity combination sensor ²	X	X
Seawater low-limit temperature sensor ²	X	
Pump sentry water sensor	X	

¹ Additional parts are not included with the standard control package.
² Available in software revision C39 and newer.

i The maximum length for the display and sensor cables is 75 ft (22.9 m).

3.2 Display features

This section explains the function of the buttons and indicators on the Elite Control display.

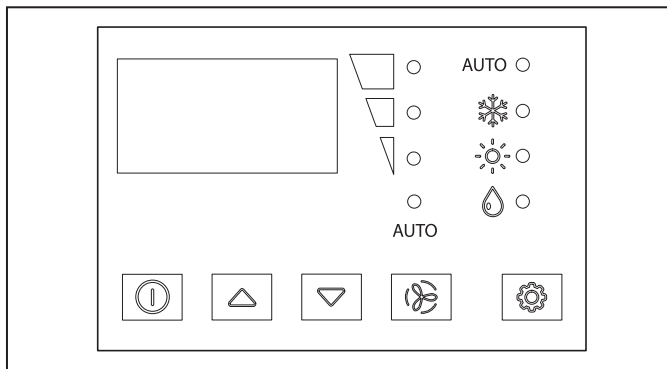

1 Elite Control display

Button	Button name	Function
	Power	Toggles between ON and OFF mode
	Up	Raises the temperature set point by 1 °F (0.6 °C)
	Down	Lowers the temperature set point by 1 °F (0.6 °C)
	Fan	Cycles through the different fan speeds
	Mode	Selects one of the four operating modes (AUTOMATIC, COOL, HEAT, or DEHUMIDIFICATION) when the system is in the ON mode

Indicator	Indicator name	Function
	Temperature LED display	Displays the inside, set point, outside, and water temperatures
	Fan speed	Indicates the fan speed as high, medium, or low
AUTO	Automatic fan mode	Located below the fan speed indicator, the LED illuminates when active
AUTO	Automatic mode	Located above the COOL mode indicator, the LED illuminates when active. <ul style="list-style-type: none"> The COOL or HEAT mode LED also illuminates to indicate which cycle is active
	Cool mode	When only this indicator is lit, it indicates the COOL-only mode is active
	Heat mode	<ul style="list-style-type: none"> When only this indicator is lit, it indicates the HEAT-only mode is active When the indicator is flashing, indicates the AUXILIARY HEAT mode is active¹
	Dehumidification mode	Indicates DEHUMIDIFICATION mode is active

¹ If parameter P-13 for the auxiliary heat is enabled, it can also be selected and the display will show A-H.

4 Specifications

The following table lists the Elite Control dimensions, cables, system inputs, and operational specifications.

4.1 Product dimensions

Display panel dimensions for the Idea bezel	4.4 in. x 3.0 in. (112 mm x 76 mm)
Display panel dimensions for the Eikon bezel	4.5 in. x 2.9 in. (114 mm x 74 mm)
Cut-out dimensions for the Idea bezel	2.3 in. x 3.5 in. (58 mm x 89 mm)
Cut-out dimensions for the Eikon bezel	1.9 in. x 2.8 in. (48 mm x 71 mm)

4.2 Cable length

Display cable self-contained	15.0 ft (4.6 m) standard
Inside air temperature sensor (optional)	7.0 ft (2.1 m) standard
OAT sensor (optional)	15.0 ft (4.6 m) standard
All custom cable lengths are supplied in standard 5 ft (1.5 m) increments	75.0 ft (22.9 m) maximum

4.3 Available system inputs

Water inlet temperature sensor (CW installations only)	1
High refrigerant pressure	1
Inside air temperature sensor (optional)	1
Low refrigerant pressure (optional)	1
OAT sensor (optional)	1
Pump sentry water sensor (optional) (DX installations only)	1
Room temperature/relative humidity combination sensor (optional)	1

4.4 Operational specifications

Set point operating range	65 °F to 85 °F (18 °C to 29 °C)
Ambient temperature operating range displayed	5 °F to 150 °F (-15 °C to 66 °C)
Sensor accuracy	± 2 °F @ 77 °F (±1 °C @ 25 °C)
Low voltage limit 100–120 V	95 VAC
Low voltage limit 200–240 V	195 VAC
Low voltage processor reset	50 VAC
Universal line voltage	100–240 VAC
Frequency	50 Hz or 60 Hz
Fan output	6 A @ 115 VAC
	6 A @ 230 VAC
Valve output	5 A @ 115/230 VAC
For CW only: auxiliary electric heater output (using compressor output L1 and L2)	30 A maximum
External triac	26 A
External Q-relay	30 A maximum
Pump output	1/4 HP @ 115 VAC
	1/2 HP @ 230 VAC
Compressor output	1 HP @ 115 VAC
	2 HP @ 230 VAC
Minimum operating temperature	0 °F (-18 °C)
Maximum ambient operating temperature	180 °F (82 °C)
Maximum Rh conditions	99% non-condensing
Power consumption	< 5 W

5 Wiring Diagrams

⚠ WARNING: ELECTRIC SHOCK HAZARD.

Turn power OFF before performing any electrical installation or maintenance activities. Failure to obey this warning could result in death or serious injury.

Figure 2 and Figure 3 provide examples of the DX and CW wiring for the Elite Control.

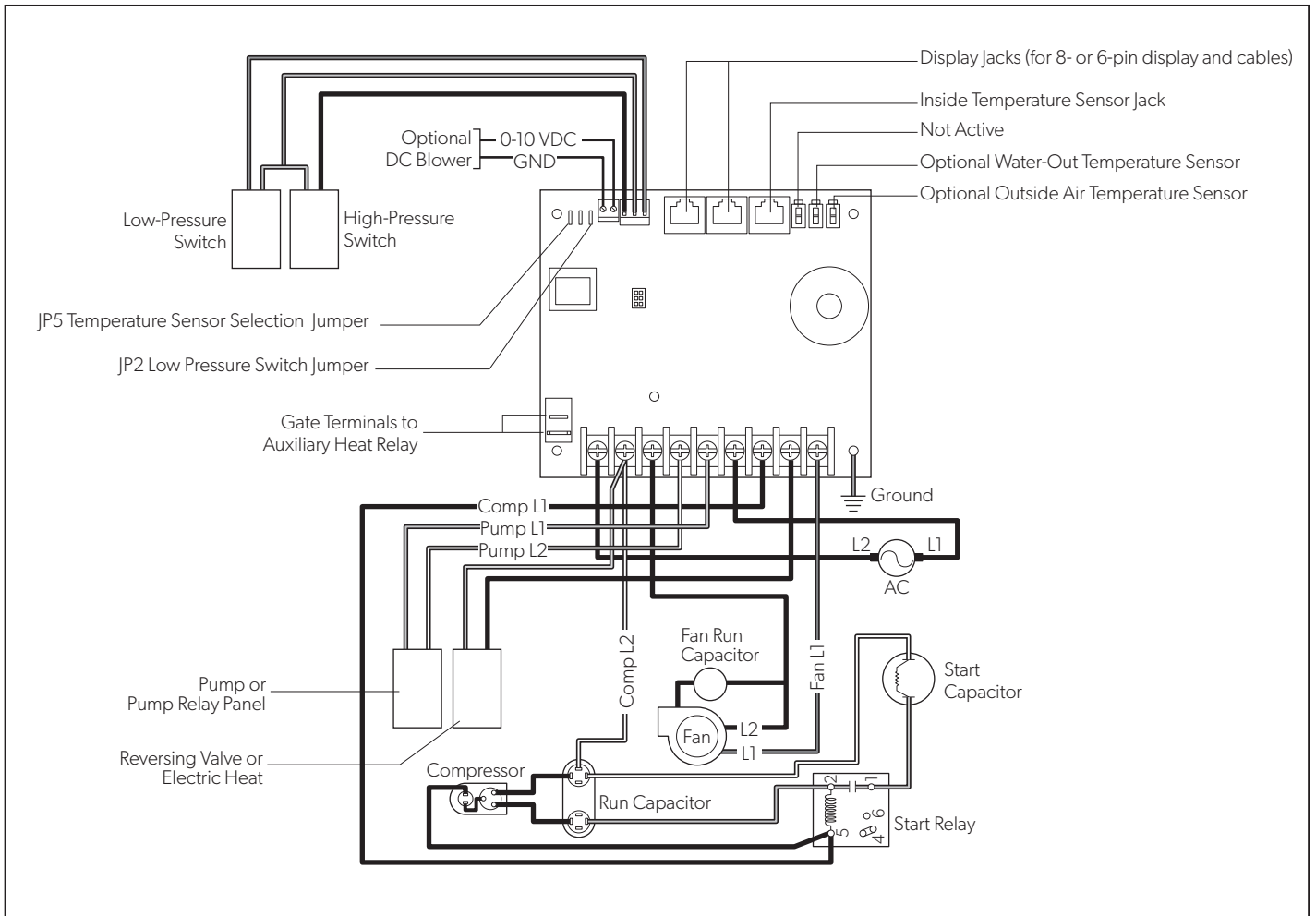

2 DX wiring diagram

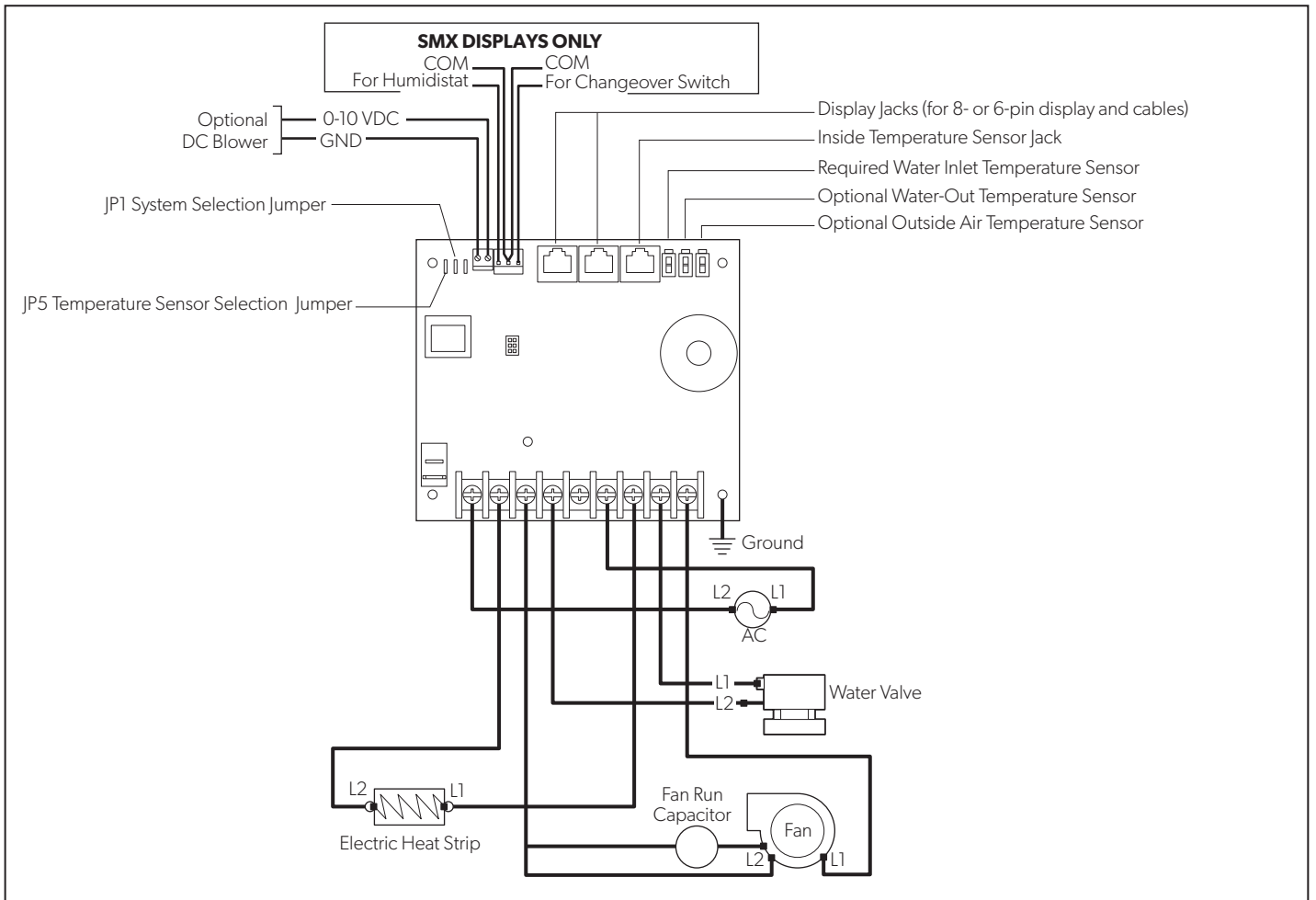

3 CW wiring diagram

6 Installation

⚠ WARNING: ELECTRIC SHOCK HAZARD.

Turn power OFF before performing any electrical installation or maintenance activities. Failure to obey this warning could result in death or serious injury.

NOTICE: Failure to obey the following notices could result in damage to the product:

- Do **not** locate the display panel in direct sunlight, near any heat-producing appliances, or in a bulkhead where temperatures radiating from behind the panel may affect performance.
- Do **not** mount the display in the supply-air stream or above or below a supply-air or return-air grille.
- Do **not** mount the display behind a door, in a corner, under a stairwell, or any place where there is no freely circulating air.
- Do **not** staple sensor cables during installation.
- Do **not** use a screw gun and do **not** over-tighten the screws when mounting the display. Either method may damage the display.

i The system's display built-in temperature sensor is located in the control's display panel. An optional inside air temperature sensor is required if installing the display panel in a cabinet, enclosed space, or any area where the accurate sensing of the room temperature would be impaired.

This section describes how to install an Elite Control.

6.1 Choosing a display panel location

Place the display panel in an area that meets the following location criteria:

- Mounted on an inside wall of the cabin, away from direct sunlight
- Sets slightly higher than mid-height of the cabin
- Located in an area of freely circulating air
- Placed a maximum distance of 15 ft (4.6 m) from the air conditioner

6.2 Preparing the wall

Cut the cabin wall to fit the display panel, according to the bezel being used.

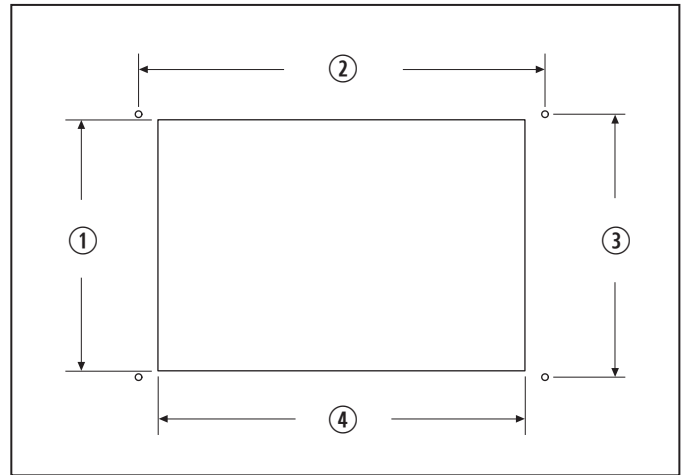

4 Idea bezel cutout dimensions

- | | |
|-------------------|-------------------|
| ① 2.3 in. (58 mm) | ③ 2.4 in. (61 mm) |
| ② 3.8 in. (97 mm) | ④ 3.5 in. (89 mm) |

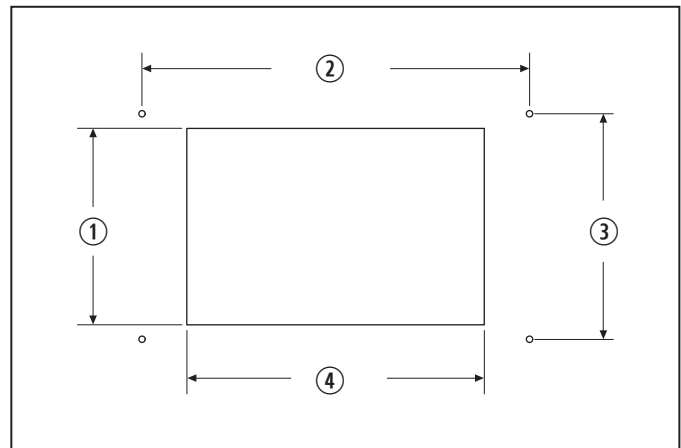

5 Eikon bezel cutout dimensions

- | | |
|-------------------|-------------------|
| ① 1.9 in. (48 mm) | ③ 2.2 in. (56 mm) |
| ② 3.8 in. (97 mm) | ④ 2.8 in. (71 mm) |

6.3 Installing an optional sensor

1. Mount the optional sensor according to the installation instructions included with the sensor.
2. Plug the sensor cable into the appropriate sensor jack on the upper side of the control board. Refer to "Wiring Diagrams" on page 7 for details on the sensor jack locations.

6.4 Mounting the display panel

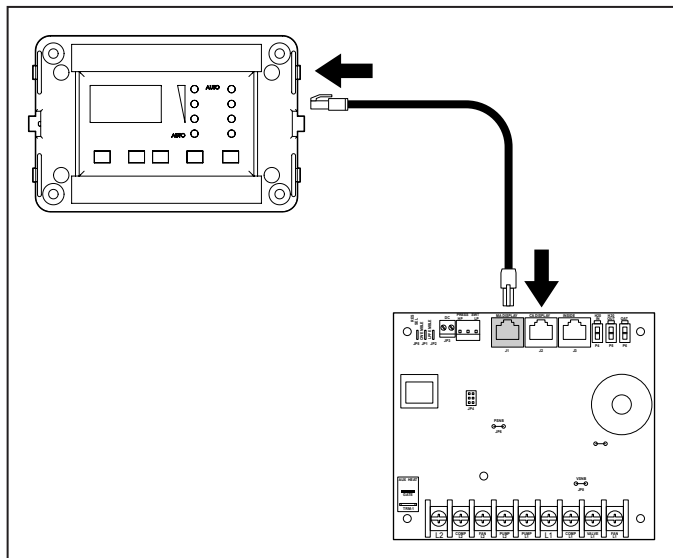

6 Plugging in the display cable

1. Plug the display cable 8-pin connector into the upper-right jack on the circuit board.
2. Insert the other end of the display cable into the display jack on the back of the display panel.

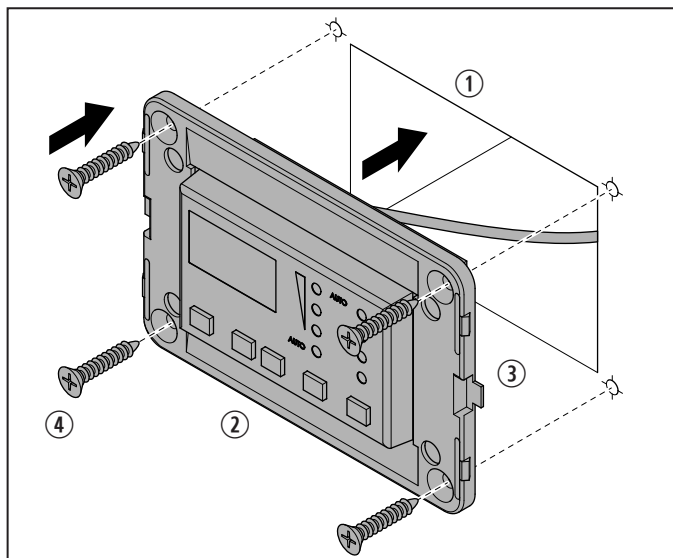

7 Securing the display

- | | |
|-----------------|---------|
| ① Cutout | ③ Bezel |
| ② Display panel | ④ Screw |

3. Use the four screws provided to secure the display panel to the bulkhead. Do not use a screw gun or overtighten the screws.
4. Snap the bezel onto the display panel frame.

6.5 Testing the display

NOTICE: For DX units only: do **not** turn the circuit breaker or power supplied to the unit OFF and then immediately turn it back ON. Allow at least five minutes for the refrigerant pressure to equalize. Failure to obey this notice could result in damage to the air conditioning unit.

1. Open the seawater-intake ball valve (seacock).
 2. Turn the display OFF. Wait a minimum of five minutes.
 3. Turn the air conditioner circuit breaker ON.
- i** If the seawater pump is on a separate circuit breaker, be sure to turn it ON.
4. Turn the display ON.
 5. Press the **Fan** button.
 6. Verify that the fan is running and that a steady airflow is coming out of the supply-air grille.
 7. Select a temperature set point lower than the current cabin temperature.
 8. Verify that a steady, solid stream of water is coming out from the overboard discharge.
 9. Verify that a steady airflow is continues to flow out of the supply-air grille.

i If the unit is not functioning as expected, refer to "Troubleshooting" on page 26.

7 Operation

NOTICE: If the unit is cool-only, change parameter P-33 to CL, then select AUTO mode. Do **not** set the unit to AUTOMATIC mode before changing parameter P-33 to CL. Cool-only units do **not** heat unless equipped with auxiliary heating. Failure to obey this notice will cause the unit to cool in both modes. Refer to "Selecting a parameter" on page 17.

i When used with optional auxiliary electric heater, the fan remains ON for four minutes after the heater cycles OFF, even if the fan is set to cycled operation.

i The images in this section show the Elite Control display, unless otherwise indicated.

This section describes the cycle, programming, and functions for the Elite Control.

7.1 Understanding the heating and cooling cycles

The heating and cooling cycles operate differently depending on the system installed. This section describes the possible cycles.

7.1.1 Normal heating or cooling cycle

In AUTOMATIC mode, heating and cooling are supplied as required to meet the cabin temperature set point.

- The system starts a cooling cycle once the cabin temperature exceeds the temperature set point by 2 °F (1 °C) and starts a heating cycle once the cabin temperature falls below the temperature set point by 2 °F (1 °C). The system continues the cycle until the cabin temperature equals the set point.
- During a cycle, the cabin temperature must drop below the set point by at least 4 °F (2 °C) before the system switches from cooling to heating or exceed the set point by at least 4 °F (2 °C) before the system switches from heating to cooling. This behavior prevents small temperature overshoots from causing the system to switch between heating and cooling when it is not necessary.

COOL mode supplies cooling only and HEAT mode supplies heating only.

- The cabin temperature for either mode is maintained within 2 °F (1 °C) of the set point by default.
- When the heating or cooling set point is satisfied, the compressor cycles OFF and the fan returns to low speed.

In Manual Fan Mode, the fan speed remains constant.

7.1.2 Chilled-water system operation (CW systems only)

In CW systems, the water valve does not open unless the water temperature is adequate to heat or cool the cabin. The adequate heating or cooling water temperature is defined by the water temperature differential setting in the control parameters. Refer to "Selecting a parameter" on page 17.

To view the current water temperature, press and hold **Power** and **Down**. Refer to "Using the control display panel" on page 14. The fan remains on low speed until the adequate water temperature is available.

- i** To provide heat when the required water temperature is not available, install the optional auxiliary electric heater and program parameter P-13. Refer to "Programming the control" on page 15.

7.1.3 Air and water temperature differential (CW systems only)

The electric heater and the chilled-water heat can affect the CW system.

The optional auxiliary electric heater overlaps with the chilled-water heat by 22 °F (12 °C). The heater turns on when required and remains on until the chilled-water temperature exceeds the ambient air temperature by 22 °F (12 °C) or until the room temperature is satisfied. During very cold conditions, the auxiliary electric heat overlaps the chilled-water heat to supplement heating.

Water temperature differential in °F Default is 15 °F (-9 °C)	Valve	Auxiliary heater
22 °F (-6 °C)	Open	Off
15 °F (-9 °C)	Open	On
7 to 15 °F (-14 to 9 °C)	Hysteresis	On
7 °F (-14 °C)	Close	On
7 to 0 °F (-14 to -18 °C)	Close	On
0 °F (-18 °C)	Close	Off
0 to -7 °F (-18 to -22 °C)	Close	Off
-7 °F (-22 °C)	Close	Off
-7 to -15 °F (-22 to -26 °C)	Hysteresis	Off
-15 °F (-26 °C)	Open	Off

7.1.4 Reversing-valve operation (DX systems only)

COOL mode or HEAT mode is determined by the position of the reversing valve. The reversing valve is programmed to automatically toggle in these situations:

- When the system is running and an opposite cycle is needed to maintain the temperature, the reversing valve will toggle to the opposite position to initiate the opposite cycle and reduce the starting surge of the compressor.
- When a cooling or heating cycle is initiated after the system has been OFF for less than five minutes.
- When a cycle is interrupted by changing the display mode to OFF or changing the set point from the display panel.

To reduce reversing-valve noise, unnecessary valve toggling is limited by default. Program the minimum compressor staging delay (parameter P-3) to five minutes or greater, to eliminate valve toggling. Refer to “Programming the control” on page 15.

i When the system is powered up, a power-on-reset always initiates a valve toggle.

7.1.5 De-icing cycle (DX systems only)

DX systems have a de-icing cycle option to prevent ice buildup on the evaporator coil during extended periods of cooling operation. Installation variables, such as grille sizes, length of ducting, insulation, and ambient temperatures, determine the runtime required to achieve the set point.

Factors that substantially increase the runtime include operating the system with hatches and doors open and programming an unrealistic set point (e.g. 65 °F/18 °C). Such situations can cause the evaporator to form ice on warm humid days.

De-icing is accomplished by closely monitoring the room air temperature in 10-minute intervals during a cooling cycle. Depending on the parameter value and the change in room temperature during these monitoring intervals, the control performs various actions to prevent ice from forming or to melt ice that has already formed. This is accomplished by short compressor shutdown periods combined with a one-speed increase in the fan speed, and by periodic HEAT mode cycles with the fan turned off.

The de-icing cycle algorithm initiates periodic compressor shutdowns every 10 minutes if the inside temperature is at or below 69 °F (20 °C). The lower the temperature, the longer the compressor shutdown will last. In addition, the de-icing cycle algorithm will perform brief reverse cycle runs (with the fan purposely turned off) if the cooling cycle runs for 40 minutes without any cooling progress or if the cooling cycle runs for more than 60 minutes, regardless of cooling progress.

The parameter setting for the de-icing feature depends on whether you are using the optional inside air temperature sensor or the display built-in temperature sensor. Installation of an optional inside air temperature sensor (located in the return air path) greatly increases the effectiveness of the de-icing feature, and this option should be considered whenever the display sensor cannot read the room temperature accurately.

For additional details on parameter settings and navigation options, refer to “Selecting a parameter” on page 17 and “Navigation tree” on page 25.

7.2 Choosing the control operation

The four Mode indicators represent the different modes of the control: COOL, DEHUMIDIFICATION, HEAT, and AUXILIARY HEAT. Refer to “Using the control display panel” on page 14.

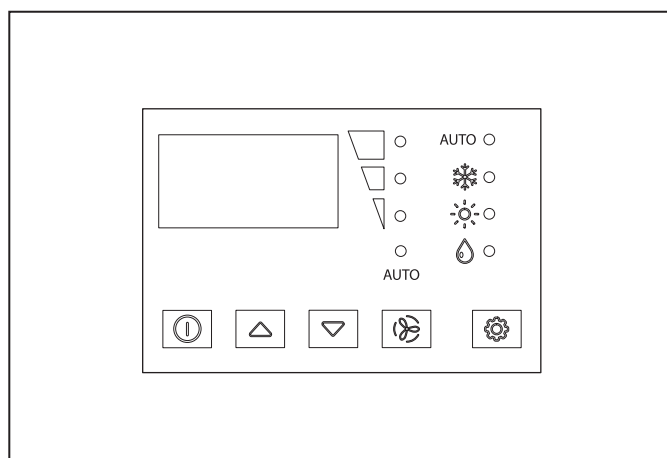





8 Choosing the control operation

1. Press and release the **Mode** button to select a mode. Refer to “Available Modes and Options for Operation” on page 13.
 - Display LEDs illuminate to indicate the selected mode.

- The display locks into the last mode selected after five seconds of inactivity, then displays the room temperature. The selected mode LED remains lit.
 - After 3 seconds of inactivity, the display shows the room temperature and enters the IDLE state.
 - To indicate an OFF state, all the display LEDs turn off.
- When the display is making a call for heating, cooling, auxiliary heat, or humidity, the appropriate Mode indicator illuminates (and flashes for auxiliary heat).
2. Press the **Power** button to wake up the control from the OFF state.

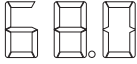

Available Modes and Options for Operation

Icon	Description/mode	Function
AUTO	AUTOMATIC	The AUTOMATIC mode LED illuminates, together with the HEAT or COOL mode LED, when the system is in AUTOMATIC mode, switching to cooling or heating as required to satisfy the temperature set-point. When AUTOMATIC mode is selected, the system provides both heating and cooling, as required.
	AUTOMATIC with auxiliary heat	The AUTOMATIC mode LED flashes when the optional auxiliary electric heater is in operation. <ul style="list-style-type: none"> • The control's display will indicate AAH. • The HEAT mode or COOL mode LED also illuminates to indicate whether the unit is cooling or heating. • In CW systems, these LEDs indicate the water-valve operating status (open or closed). No water-valve status is indicated when the system is in manual HEAT or COOL modes.
	COOL	The COOL mode LED illuminates when the COOL mode is selected or when the unit is in an AUTOMATIC mode cooling cycle. Only the cooling system operates. If the ambient temperature drops below the set point, the system will not automatically switch to the HEAT mode.
	HEAT	The HEAT mode LED illuminates when the HEAT mode is selected or when the unit is in an AUTOMATIC mode heating cycle. Only the heating system operates. If the ambient temperature rises above the set point, the system will not automatically switch to the COOL mode. When the unit is heating with auxiliary heat, the HEAT mode LED will flash to differentiate from reverse cycle heating.
	DEHUMIDIFICATION	The DEHUMIDIFICATION mode LED illuminates when the DEHUMIDIFICATION mode is selected. This mode controls humidity during periods when the vessel is unoccupied and prevents the cabin temperature from dropping below the minimum default temperature setting. During humidity control: <ul style="list-style-type: none"> • The fan circulates air for 30 minutes. • Air temperature is sampled and recorded. • After 30 minutes, a cooling cycle starts and continues until the temperature is lowered 2 °F (1 °C) or until the cooling cycle runs a maximum of one hour. • Four hours after the temperature is satisfied or the cooling cycle times out, the cycle repeats. For temperature control: <ul style="list-style-type: none"> • After the 30-minute fan circulation, if the sampled temperature is at or above the factory default setting 50 °F (10 °C), a cooling cycle begins and runs for humidity control. • If the temperature is below 50 °F (10 °C), a heating cycle begins. The heating cycle continues until the temperature reaches 50 °F (10 °C) or until the heating cycle runs a maximum of one hour. • Four hours after the temperature is satisfied or the cooling/heating cycle times out, the cycle repeats, each time determining whether cooling or heating is required. <p> For DX systems only: the DEHUMIDIFICATION mode heat cycle will not run when the ambient temperature is below 40 °F (4 °C). This protects the condenser coil from freezing. Systems configured with electric heat will run the DEHUMIDIFICATION mode heat cycle regardless of the cabin temperature.</p>
	ON	All control outputs are on and the display indicates the current state of operation. The display shows the cabin temperature. All parameters operate as set.

Available fan modes and options for operation

Press and release the **Fan** button to select a fan mode. Refer to “Available Modes and Options for Operation” on page 13.







- Display LEDs illuminate to indicate the selected mode.

Indicator	Description/mode	Function
AUTO	Automatic fan	<p>The automatic fan mode balances the most efficient temperature control with a slower, quieter fan speed. This mode selects the fan speed automatically based on the temperature differential. To select automatic fan mode, press and release the Fan button until the AUTO LED below the Manual Fan indicator illuminates on the display.</p> <ul style="list-style-type: none"> • The auto fan speeds are automatic based on default and programmed values. Program menu parameter settings P-1, P-2, and P-32 determine the maximum, minimum, and middle fan speed settings. • Fan speed decreases as the temperature set-point is approached in COOL mode and operates at low speed when the set point is reached. • The automatic fan speed operation can be reversed for HEAT mode when parameter P-12 is set to rEF. Refer to “Programming the control” on page 15. <p>i Refer to “Selecting a parameter” on page 17. Once high and low fan speed limits are set, the unit automatically readjusts the remaining fan speeds in both automatic and manual fan modes.</p>
	Manual fan	<p>The manual fan LED illuminates to indicate the current fan speed. There are three manual fan speeds available. The number of bars illuminate (1=low, 2=medium, and 3=high) on the display when selected.</p> <ul style="list-style-type: none"> • Press and release the Fan button to advance from automatic to manual fan operation. • Press and release the Fan button to cycle through the manual fan speeds, from low to high. • Press and release the Fan button to return to automatic fan operation.
	Fan-only	<p>Use fan-only to operate the fan for air circulation when no cooling or heating is desired.</p> <ul style="list-style-type: none"> • From the OFF mode, press and release the Fan button to select a desired fan speed. <p>i Turning the control ON reverts the fan to the AUTOMATIC mode or the last selected manual fan setting.</p>
CYN / CON	Cycled / continuous fan	<p>The fan can be set to run continuously whenever the system is turned ON, or it can be set to cycle ON and OFF in conjunction with the cooling or heating cycles.</p> <ul style="list-style-type: none"> • Press and hold the Fan button for five seconds. <ul style="list-style-type: none"> – CYC displays when the operational setting is set to cycled. When used with an optional auxiliary electric heater, the fan remains on for 4 minutes after the heater cycles off. – CON displays when the operational setting is set to continuous.

7.3 Using the control display panel

The following table details the button combinations to use to achieve different functions on the control.

Button combinations	Button names	Function
	Fan, Up, & Down	<p>Lock and unlock the keypad: Press simultaneously to toggle the keypad lock on or off. The display shows LC when the keypad is locked, or UL when the keypad is unlocked.</p> <p>For software revisions B28 and newer, view some indicators even if the keypad is locked:</p> <ul style="list-style-type: none"> • (CW only) To view the chilled-water-inlet temperature, simultaneously press the Power & Up buttons • (DX only) To view the pump sentry water temperature, simultaneously press the Power & Up buttons (P-8 must be on) • (DX only) To view the sea water low-limit temperature, simultaneously press the Power & Down buttons

Button combinations	Button names	Function
	Up & Down	Display the outdoor temperature: Press simultaneously and hold. The display shows the outdoor temperature reading while this combination is held.
	Power & Down	Display the chilled-water-inlet temperature: Press simultaneously and hold.
	Power & Up	CW only: Display the chilled-water-inlet temperature: Press simultaneously and hold. DX only: Display the pump sentry water temperature: Press simultaneously and hold.
	Mode & Up	Enter the programming menu: <ul style="list-style-type: none"> • With the control in OFF mode, press the following buttons in this order: Mode, Up, Down, and Mode. P1 appears on the display. The display will alternate between the parameter number and the current setting. • Navigate using the Mode and Fan buttons and adjust a parameter setting using the Up and Down buttons. • Press the Power button once to save changes and return to OFF mode.
	Up & Down	Set new default parameters: While in PROGRAM mode, press simultaneously and hold for three seconds.
	AC Power set to Off & then Mode, Power, or Down	Disconnect the AC power, then press the specified button immediately after reconnecting the AC power and while all LEDs are illuminated during power-on reset for the following information. <ul style="list-style-type: none"> • View the fault history log: press the MODE button. • Exit the fault history log: press the POWER or MODE button once, and wait 30 seconds. • Clear the fault history log: press simultaneously the POWER and DOWN buttons while viewing the fault history log. • Display the compressor run-time hour meter: press the DOWN button. This meter displays hours of compressor usage, with a maximum capture time of 65,536 hours. • Enter the self-test program: press the POWER button. Use the self-test program to diagnose problems and test the air conditioning system.
	Power & Mode	Restore factory default settings: <ul style="list-style-type: none"> • Turn off the air conditioning unit. • Press simultaneously and hold the POWER and MODE buttons. • Turn the air conditioning unit on, and then release the buttons when the display reads IP.

7.4 Programming the control

i If your AC has a Shaded-Pole (SP) fan motor instead of a Split-Capacitor (SC) High-Velocity (HV) fan motor, you must change the parameter P-14 setting to shaded-pole (SP) before operating the equipment. SP units are recognizable by an overhanging blower motor. Only reprogram the fan motor type parameter if you do not have an HV blower.

- i** For CW Only: Standard air handlers come equipped with chilled-water bypass valves. However, for no-valve air handlers, the fan must be set to cycle on demand (CYC).
- i** For DX Only: If your air conditioning unit is cool-only (if it does not have a reversing valve), you must change the parameter P-33 setting from heat pump (HP) to cool only (CL). Refer to "Selecting a parameter" on page 17.
 - You must change the parameter before setting the Automatic mode for a cool-only unit.

- Once this parameter is set, the only allowable modes are OFF, COOL, AUXILIARY HEAT, and DEHUMIDIFICATION.
- If the AUTOMATIC mode is selected and the thermostat calls for heat, the compressor will run. Since there is no reversing valve, the air conditioning unit will supply cool air when heating is desired. Cool-only units do not heat unless equipped with auxiliary heating.

Parameter settings are used to program and fine-tune the system for the most efficient operation within an installation and to adjust operating parameters for your particular needs. After new values are entered and memorized, the factory defaults are overwritten and the new parameters become the default values.

Should the Elite lose power, the operating parameters are retained. When power is restored, the control resumes operating as last programmed.



The control has factory default values stored in permanent memory (memorized factory default settings) that can be recalled if you have any programming difficulties. You can restore the original factory default parameters manually. Refer to “Selecting a parameter” on page 17 for a summary of the parameters, the permitted values, and original factory default settings.

7.4.1 Entering programming mode

1. While the control is in the OFF mode, press the following buttons in this order: **Mode**, **Up**, **Down**, and **Mode** to enter the programming menu. P-1 appears on the display. The display will alternate between the parameter number and the current setting.
2. Use the **Mode** and **Fan** buttons to navigate to different parameters (P-1, P-2, P-3, etc.).
3. Press the **Up** and **Down** buttons to adjust a parameter setting.
4. Press the **Power** button once to save any changes and to return to OFF mode. If no button is pressed for 50 seconds, the system will exit the Program mode and return to OFF mode automatically.







7.4.2 Selecting a parameter







The following table describes the parameters available for the Elite Control.





Parameter	Name	DX	CW	Factory default	Parameter range
P-1	High fan limit	x	x	95	51–95
		Select a higher number to increase the fan speed, a lower number to decrease the fan speed.  The 35-95 parameter range setting is applicable to software revision #B24 and newer.			
P-2	Low fan limit	x	x	50	30–50
		Select a higher number to increase the fan speed, a lower number to decrease the fan speed.			
P-3	Compressor staging time delay	x		15	5–135 seconds
		Use for installations where more than one system operates from the same power source. Different staging delays allow compressors to start at different times when the power is interrupted. Stage the units at least five seconds apart.			
P-4	Inside air temperature sensor calibration	x	x	Ambient temperature	Ambient temperature ± 10 °F (6 °C)
		Calibrate the sensor to display the correct room temperature reading. The setting increments are in °F even when the control is set to display °C.			
P-5	Failsafe level	x		3	0 = Minimal Protection ¹ 1 = Continuous No Display ² 2 = Continuous With Display ² 3 = Four Failures, Reset Required
		 ¹ Part of the functionality of this setting is only applicable to software revision #C40 and newer. ² The setting is applicable to software revision #C39 and older.			
		Refer to “Fail safe levels” on page 24.			
P-6	Low voltage monitor	x		OFF	OFF, 95 VAC/195 VAC
		Set the built-in voltmeter circuit that monitors the AC input voltage prior to each cooling or heating cycle when set to 95 VAC or 195 VAC. <ul style="list-style-type: none"> For 100–120 VAC input power, set to OFF or 95. For 208–240 VAC input power, set to OFF or 195.  The setting is applicable to software revision #A15 and newer.			

Parameter	Name	DX	CW	Factory default	Parameter range
P-7	De-icing cycle	x		OFF	OFF 1 = ON with 5 °F (3 °C) Display Sensor Differential 2 = ON with 7 °F (4 °C) Display Sensor Differential
Select the parameter setting for the de-icing feature depending on whether you are using the display built-in temperature sensor or the optional inside air temperature sensor. <ul style="list-style-type: none"> If using an optional inside air temperature sensor., set this parameter to 1 to turn the de-icing feature ON, or to OFF to disable. If using the display built-in temperature sensor, choose one of the two selectable behavior modes: <ul style="list-style-type: none"> 1: assumes the display built-in temperature sensor may be reading the room temperature as much as 5 °F (3 °C) greater than the actual evaporator temperature (standard). 2: for more extreme installations - assumes the display built-in temperature sensor may be reading the room temperature as much as 7 °F (4 °C) greater than the actual evaporator temperature. The setting of 2 should only be used if a setting of 1 does not prevent evaporator ice from forming. <p>i The following applies to software revision #A13 and older. De-icing is accomplished by switching the reversing valve to HEAT mode while the system is cooling. The valve remains energized for the programmed cycle time. The cycle is programmable to OFF or to a period of one, two, or three minutes.</p> <p>i The following applies to software revision #A15 and newer. De-icing is accomplished by closely monitoring the room air temperature in 10-minute intervals during a cooling cycle. Depending on the parameter value and the change in room temperature during these monitoring intervals, the control performs various actions to prevent ice from forming or to melt ice that has already formed. These actions include short compressor shutdown periods combined with a one-speed increase in fan speed and by periodic HEAT mode cycles with the fan turned off.</p>					
P-8	Optional pump sentry	x		OFF	OFF ON = Select 100 °F to 150 °F (38 °C and 66 °C)
Set this parameter setting when the optional pump sentry water sensor is installed to monitor the condenser coil temperature and to shut down the pump and compressor when the coil temperature rises above the programmed value. This sensor is plugged into the H2O OUT sensor jack on the control board.					
Program a temperature between 100 °F and 150 °F (38 °C and 66 °C), depending on seawater temperature and the system type. Refer to the sensor installation instructions for detail. The setting increments are in °F even when the control is set to display °C.					
P-9	Display brightness control	x	x		4 (Dimmest)–18 (Brightest)
Set this parameter setting between 4 and 18. A dark cabin requires a setting of 4. A very bright cabin requires a setting of 12–18.					
P-10	Fahrenheit or Celsius selection	x	x	F	F = Fahrenheit displayed C = Celsius displayed A = Automatic selection based on voltage 50 Hz = Celsius 60 Hz = Fahrenheit
Select °C for Celsius. (Celsius readings are displayed in tenths, for example 22.2°). The default setting is °F.					
P-11	Cycle pump with compressor	x		CYC	CYC = Cycle with compressor Con = Continuous pump
Select cycled or continuous pump operation: <ul style="list-style-type: none"> CYC: increases the pump life and conserves electricity by cycling ON and OFF with the compressor. Con: programs the pump to operate continuously whenever the system is on. 					
P-12	Reverse automatic fan speeds during heating	x	x	rEF	nOr = Normal fan operation rEF = Reversed fan in HEAT mode
Reverse the automatic fan speeds during HEAT mode to improve heat output in cooler climates. <ul style="list-style-type: none"> When set to rEF, the fan speeds up as the set point is approached. The fan switches to low speed when the set point is satisfied and the water valve or compressor cycles OFF. When set to nOr, the fan operates the same as during cooling, which represents normal fan operation. 					

Parameter	Name	DX	CW	Factory default	Parameter range
P-13	Auxiliary heat enable	x	x	nOr	nOr = Disable A-H = Auxiliary electric heat
		<p>Enable the operation of an optional auxiliary electric heater that if installed, can heat an individual cabin when the chiller system is in cooling mode. Refer to “Wiring Diagrams” on page 7.</p> <p>i The following is applicable to software revision #A13 and older. When this parameter is programmed for auxiliary electric heat, only the electric-heat relay located toward the middle of the circuit board is energized during a heating cycle.</p> <p>i The following is applicable to software revision #A15 - #C30. When programmed for auxiliary electric heat, both the electric-heat relay and the valve relay are energized. This change supports newer circuit board revisions without the electric-heat relay. Please consult with Dometic Customer Service or with an authorized service technician for assistance.</p> <ul style="list-style-type: none"> For CW systems: Circuit boards that do not have electric-heat relays require a display with software revision A15 or newer to properly energize the compressor relay. Also, when using this configuration, the electric heater L-1 connection must be connected to the COMP L-1 terminal on the AH-Passport I/O or U-board. For DX systems: Circuit boards that do not have electric-heat relays require a display with software revision A15 or newer to properly energize the valve relay. Also, since the valve-relay output only supports a maximum of 15 amps at 115VAC or 10 amps at 230 VAC (PPIO circuit boards revision F and newer) of resistive load, when installing an optional electric heater that exceeds this load, it is necessary to install an additional contactor that is rated to handle the full load of the electric heater.” 			
P-14	Fan motor selection	x	x	SC	SC = Split capacitor fan motor SP = Shaded Pole Fan Motor
		Set to SC for AC switch high-velocity blowers. Set to SP if your unit has a Shaded Pole fan motor. Refer to “Programming the control” on page 15.			
P-15	Restore factory default settings	x	x	nOr	rST = Reset defaults nOr = Normal
		To reset all programming parameters, set this parameter to rST. This restores all programmable parameters to the factory default values.			
P-16	Hydronic water valve forced open		x	nOr	OPn = Valve forced open nOr = Normal operation
		<p>Open the water valve to bleed air from the system.</p> <ul style="list-style-type: none"> OPn: forces the valve open for four hours while the control is turned OFF. If the control is turned ON or if AC power is interrupted during this four-hour period, the valve override is canceled. nOr: returns the valve to normal operation. 			
P-17	Water temperature differential		x	15 °F (8 °C)	5 °F to 25 °F (3° C to 14 °C)
		<p>Set the temperature differential between the ambient air temperature and the hydronic water temperature that controls the water valve. For example, selecting 10 °F (-12 °C) opens the valve when the water temperature is 10 °F (-12 °C) less than the ambient temperature in the cooling mode and 10 °F (-12 °C) greater than the ambient temperature in the heating mode.</p> <p>Careful selection of the temperature differential can fully utilize the ship’s heating and cooling resources. For example, while in cooling mode and using a 10° F (-12 °C) value, the valve will open to allow some cooling while the hydronic system is coming down to temperature. Refer to “Air and water temperature differential (CW systems only)” on page 11 for a graphical explanation of this parameter.</p>			

Parameter	Name	DX	CW	Factory default	Parameter range
P-18	Air filter cleaning/ replacement timer setting	x	x	0	10-250 Displays the elapsed time (in hours x10) since the timer was started or reset.
		Establish a reminder to clean or replace the air filter. FIL flashes briefly on the LED display every 10 seconds until it is cleared. The FIL reminder can only be cleared and the timer reset via the programmable parameter P-19. <ul style="list-style-type: none"> The parameter entered represents that number times 10 hours. Select the number of operating hours until the filter reminder appears. Parameter choices are between 10 (100 hours) and 250 (2500 hours). Press the Down button to reset the value to 0, restart the timer, and clear the reminder. <p> This setting is applicable to software revision #A15 and newer.</p> <p> Dometic recommends checking the air filter at least every 500 hours of operation.</p>			
P-19	Filter cleaning/ replacement timer value & reset	x	x	0	Displays the elapsed time (in hours x10) since the timer was started or reset.
		Display the current elapsed time (in hours x 10) since the timer was started or reset. When this parameter value reaches the value set in parameter P-18, FIL flashes on the display every 10 seconds until cleared. Press the Down button to reset the value to 0, restart the timer, and clear the reminder. <p> This setting is applicable to software revision #A15 and newer.</p>			
P-20	CAN Bus unit ID	x	x	dIS unit ID = 59 (after enabling and power cycling)	0-255
		Enables all units with a CAN Bus adapter installed to be networked together and communicate with each other or the ship's CAN Bus system (with additional translator equipment in some cases). <ul style="list-style-type: none"> The Elite must be plugged into networked Passport I/O and U-boards (this parameter does not display if the Elite is plugged into a standard board). Each control on the same CAN bus network must be assigned a unique Unit ID (0 - 255). Enter the unit's CAN Bus Unit ID number. <p> This setting is applicable to software revision #A16 and newer.</p>			
P-21	CAN Bus group ID	x	x	58 (after enabling and power cycling)	0-255
		Enables all units with a CAN Bus adapter installed to be grouped together in a network system and communicate with the ship's CAN Bus system (with additional translator equipment in some cases). <ul style="list-style-type: none"> The Elite must be plugged into networked Passport I/O and U-boards (this parameter does not display if the Elite is plugged into a standard board). Each control on the same CAN bus network must be assigned a unique Unit ID (0 - 255) Enter the unit's CAN Bus Group ID number. <p> This setting is applicable to software revision #A16 and newer.</p>			
P-22	Voltage calibration	x	x	AC voltage	Adjust to match the accurate voltage reading.
		Displays a live reading of the voltage being read by the circuit board. Use the Up and Down buttons to calibrate for a more accurate voltage level when calculating low voltage for parameter P-6. Use a reliable voltmeter during adjustment. <p> This setting is applicable to software revision #A15 and newer.</p>			

Parameter	Name	DX	CW	Factory default	Parameter range
P-23	Set point temperature differential	x	x	2	1 = 1 °F (.6 °C) differential 2 = 2 °F (1 °C) differential Set the temperature differential in Fahrenheit for all modes of operation: AUTOMATIC, COOL, HEAT, or AUXILIARY HEAT. Refer to "Choosing the control operation" on page 12. <ul style="list-style-type: none"> 1: maintains the room temperature ± 1 °F (0.6 °C) from the desired set point. 2: maintains the room temperature ± 2 °F (1 °C) from the desired set point.  This setting is applicable to software revision #B23 and newer.
P-24	Dehumidification mode minimum temperature	x	x	50 °F (10 °C)	40 °F to 75 °F (4 °C to 24 °C) Set the minimum room temperature (in Fahrenheit) for which DEHUMIDIFICATION mode initiates a cooling cycle to remove moisture from the air. If the room temperature is below this parameter setting, DEHUMIDIFICATION mode runs a heating cycle. Refer to "Choosing the control operation" on page 12.  This setting is applicable to software revision #B23 and newer.
P-25	Auto fan speed temperature differential	x	x	2 °F (1 °C)	1 °F to 3 °F (0.6 °C to 2 °C) Set the incremental differential (with cumulative steps) between the ambient temperature and the set point temperature at which the fan speed will increment to the next speed.  A 1 °F (0.6 °C) hysteresis in the auto fan speed differential prevents the speed from changing if the room temperature changes. In addition, programming parameters P-12 and P-23 both have an effect on the operation of the auto fan speed.  This setting is applicable to software revision #B24 and newer.
P-26	Supply air high temperature limit	x	x	OFF	OFF 95 °F to 140 °F in 5° increments (35 °C to 60 °C in 2.8° increments) Set the maximum supply air-discharge temperature allowed. <ul style="list-style-type: none"> Enabling this parameter has no effect unless parameter P-13 is enabled and set to A-H. Use of this parameter requires that the OAT sensor be placed in the supply air stream immediately downstream of the blower discharge. HEAT mode shuts down if the temperature of this sensor exceeds the setting. HEAT mode is restored when a 10 °F (6 °C) hysteresis is satisfied or when power is cycled to the control and the OAT sensor temperature is less than the setting but still within the hysteresis. SAH is displayed when this fault occurs. Display the discharge temperature by pressing the Up and Down buttons simultaneously (same as viewing the outside air temperature).  This setting is applicable to software revision #B24 and newer.
P-27	Seawater low-limit adjustment	x		40 °F (4.4 °C)	35 °F to 50 °F (2 °C to 10 °C) If the optional seawater low-limit adjustment sensor is connected to the control board H2O Out 2-pin plug, set the system to switch from reverse-cycle heat to auxiliary electric heat (if an auxiliary electric heater is installed and enabled). <ul style="list-style-type: none"> When the seawater temperature drops below 40 °F (4 °C) (default) and the reverse-cycle heat has operated more than five minutes. Once the seawater rises 3 °F above the seawater low-limit adjustment sensor temperature set point, the system returns to reverse-cycle heating. If an auxiliary electric heater is not installed, the system will shut down and flash LSF when the seawater drops below 40 °F (4.4 °C). Once the seawater rises 3 °F above the seawater low limit temperature, the system automatically goes back into reverse-cycle heating and stops flashing LSF.  This setting is applicable to software revision #C39 and newer.

Parameter	Name	DX	CW	Factory default	Parameter range
P-28	Relative humidity enable	x	x	OFF	50–80
		<p>Enable the optional room temperature/relative humidity combination sensor. This allows the system to dehumidify using auxiliary electric heat (if an auxiliary electric heater is installed and enabled) when the cabin humidity rises above the selected relative humidity (RH).</p> <ul style="list-style-type: none"> For DX applications: Relative humidity enabled. If the optional room temperature/relative humidity combination sensor is connected to the control board and senses that the humidity has increased, the compressor run time will extend by operating to 1 °F lower than the set point to remove the humidity. If an auxiliary electric heater is installed, it will cycle ON and OFF to maintain the set point while the compressor stays on longer to dehumidify. <p> There could be a period of overlap when the compressor and the auxiliary electric heater are on at the same time. This cycle continues until the cabin’s relative humidity is less than less than the humidity set point.</p> <ul style="list-style-type: none"> For CW applications: Relative humidity enabled. If the optional room temperature/relative humidity combination sensor is connected to the control board, this feature allows the system to dehumidify with electric heat (if an auxiliary electric heater is installed and enabled) when the cabin humidity rises above the humidity set point. The auxiliary electric heater will cycle ON and OFF to maintain the set point while the bypass valve opens to allow cold loop water to enter the air handler coil to dehumidify. This operation continues until the cabin’s relative humidity is less than the humidity set point. If an auxiliary electric heater is not installed, the ON time of the bypass valve will extend by operating to 1 °F lower than the set point. This cycle continues until the cabin’s relative humidity is less than the humidity set point. The range of adjustment for the relative humidity is 50% to 80% RH. <p> This setting is applicable to software revision #C39 and newer only.</p>			
P-29	High-pressure switch test	x	x	DIS	nOr = closed circuit (OK) OPn = open circuit (fault/overcharged/low water flow)
		<p>Allow a test on the high-pressure circuit to identify an overcharged system or loss of water flow.</p> <ul style="list-style-type: none"> The unit will operate in COOL mode at high fan speed, and display nOr (closed circuit) if the high-pressure switch circuit is OK. If the high-pressure switch circuit has a fault, is over-charged, or has a loss of water flow, the system will display OPn (open circuit). Press the MODE button to enter the low-pressure switch test, and press the FAN button to exit the test mode. <p> This setting is applicable to software revision #C39 and newer only.</p>			
P-30	Low-pressure switch test	x	x	DIS	nOr = closed circuit (OK) OPn = open circuit (fault/undercharged)
		<p>Allow a test on the low-pressure circuit to identify a fault or a low charge. This test can also be used to charge a system.</p> <ul style="list-style-type: none"> The unit will operate in COOL mode at high fan speed, and display nOr (closed circuit) if the low-pressure switch circuit is OK. If the low-pressure switch circuit has a fault or the system is low on charge, the system will display OPn (open circuit). Press the MODE button to enter the low-pressure switch test, and press the FAN button to exit the test mode. <p> This setting is applicable to software revision #C39 and newer only.</p>			
P-31	Reserved				
P-32	Medium fan speed	x	x	75	33 to 95
		<p>Adjust the speed assigned to the medium fan setting. Set a higher number to increase the fan speed or a lower number to slow the fan speed.</p> <p> This setting is applicable to software revision #C39 and newer only.</p>			

Parameter	Name	DX	CW	Factory default	Parameter range
P-33	Cool-only mode	x		HP	HP = heat pump mode CL = cool or (optional) electric heat mode
		Select heat pump or cool-only operation. <ul style="list-style-type: none"> Selecting HP operates the unit in the default heat pump mode, which allows for cooling, reverse cycle heating, or (optional) auxiliary electric heat. Selecting CL operates the unit in COOL or (optional) AUXILIARY HEAT modes. AUXILIARY HEAT mode is available only if the unit is equipped with an auxiliary electric heater. <p>i Selecting CL initiates a five-minute compressor delay whenever the compressor shuts down on the set point, a fault, or a power outage. The delay begins immediately after compressor shuts down. The display will show a flashing pixel in the bottom right corner every second during the five minute countdown period. If the five-minute delay period has passed before the compressor is called to operate, the compressor will come on with no delay.</p> <p>i This setting is applicable to software revision #C39 and newer only.</p>			

7.4.3 Exiting programming mode

To exit the programming menu manually, press the Power button to return to OFF mode. Alternatively, the display automatically exits the programming menu after 50 seconds of inactivity.

7.4.4 Identifying the software version

The control’s software version (such as “39”) appears in the display for three seconds prior to the manual or automatic exit from the programming mode. The control enters OFF mode after exit.

7.4.5 Identifying programming fault codes

To protect the unit, certain fault conditions trigger a lockout that shuts down the control. The control will not restart until the fault is repaired. The type of lockout associated with the fault depends on the type of fault detected (refer to the Fault and status codes table) in combination with the level of protection (refer to the Fail safe levels table) that was programmed in the P-5 parameter (refer to “Selecting a parameter” on page 17).

Fault and status codes

Code	Description	DX	CW
HPF	High pressure switch fault: indicates high refrigerant pressure. This fault is not applicable in HEAT mode.	x	
LPF	Low pressure switch fault: indicates low refrigerant pressure. This fault has a three-minute shutdown delay (for display firmware #41 and newer).	x	
PLF	Low pump flow fault: indicates high-water temperature in the condensing coil or low pump flow.	x	
ASF	Inside sensor: indicates the display built-in temperature sensor is damaged or not connected.	x	x
FIL	Indicates the air filter replacement timer has expired.	x	x
SAH	Indicates a high supply air temperature limit.	x	x
LC/UL	Indicates a locked or unlocked display mode, although some buttons do function. Refer to “Using the control display panel” on page 14.	x	x
LSF	Indicates a seawater low limit.	x	
LAC	Low voltage fault: indicates low voltage. This fault offers extra protection for the compressor and components within the system during low-voltage (brownout) conditions.	x	

Fail safe levels

Lvl	Description	DX only
0	<p>Fail Safe Level 0: Temporary failsafe, limited to five-minutes (only in display firmware #C40 and newer). Provides minimal failsafe protection and is not recommended.</p> <ul style="list-style-type: none"> The system will automatically switch back to Level 3 after five minutes (for display firmware #C40 and newer. Any older display firmware will not revert to full detection). Only the ASF fault is detected and displayed. The control shuts down and will not restart until the fault is repaired. Once repaired, the control restarts after a two-minute delay. 	
1	<p>Fail Safe Level 1 (only for display firmware #C39 and older): includes the failsafe actions of the previous level and detects all other faults, but they are not displayed.</p> <ul style="list-style-type: none"> The system shuts down for two minutes or until the fault is cleared, whichever is longer. The system restarts when the fault is cleared. 	x
2	<p>Fail Safe Level 2 (only in display firmware #C39 and older): includes the failsafe actions of the previous levels and displays all other faults.</p> <ul style="list-style-type: none"> The system shuts down for two minutes or until the fault is cleared, whichever is longer. The system restarts when the fault is cleared. 	
3	<p>Fail Safe Level 3: includes the failsafe actions of previous levels and the system will lockout after four consecutive HPF, LPF or PLF faults. In addition, the lockout can be cleared.</p> <ul style="list-style-type: none"> The system shuts down for two minutes or until the fault is cleared, whichever is longer. To clear the lockout, enter OFF mode. Then, return to ON mode. 	

7.5 Navigation tree

This section shows the menu navigation for the Elite Control.

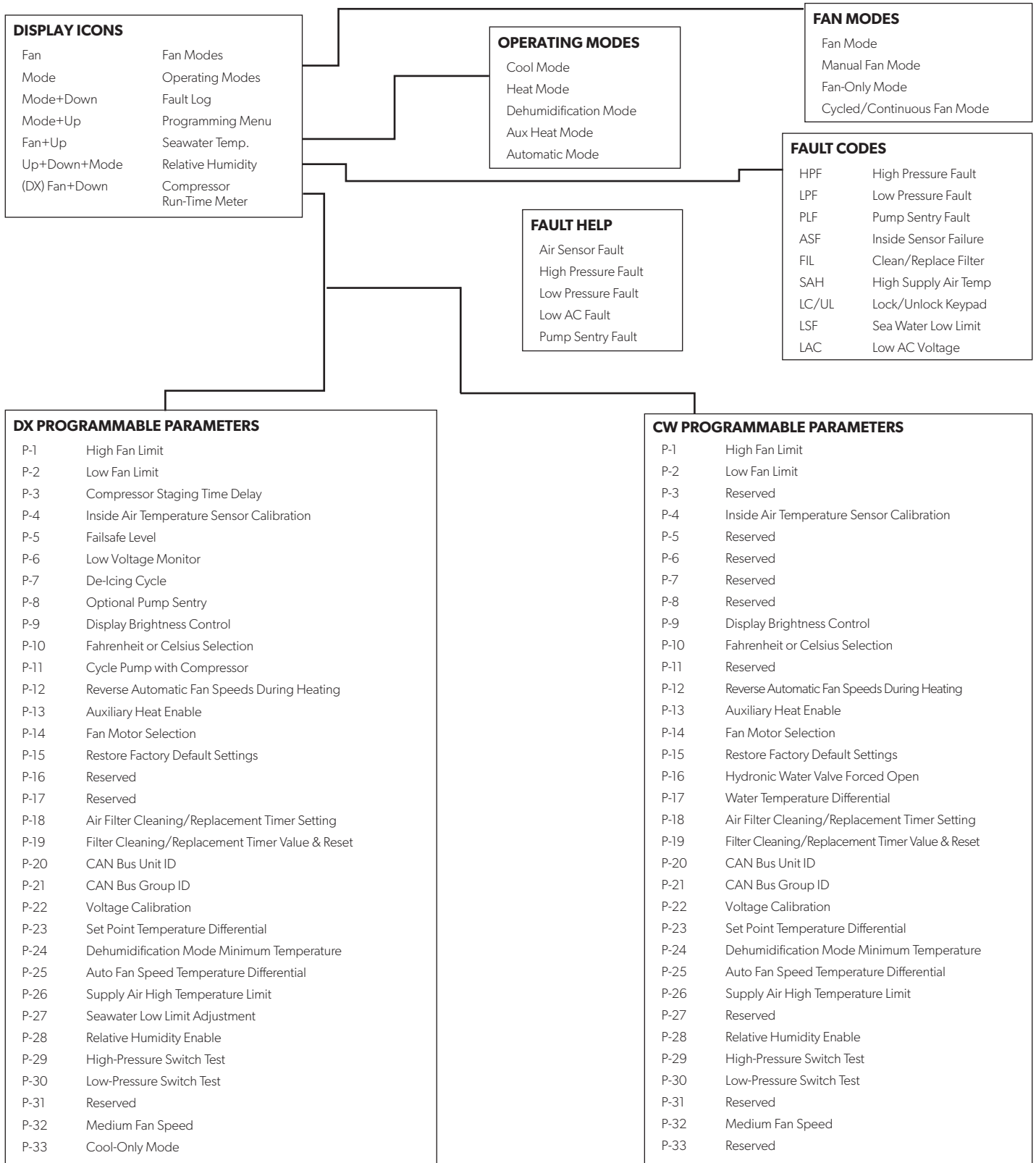

8 Troubleshooting



The following table describes some common occurrences that are not a result of defective workmanship or materials.

Problem	Possible causes	Recommended solution
The system does not power up.	The air conditioning unit circuit breaker is off.	Turn on the air conditioning unit circuit breaker at the ship's panel.
	The display is not turned on.	Turn on the display.
	The terminal strip is miswired.	Check the wiring diagram and correct if necessary.
	The input-line voltage is insufficient. 7	<ul style="list-style-type: none"> Check the power source (shore/generator) for proper voltage. Check the wiring and terminals for proper sizes and connections. Verify with a voltmeter that the power at the unit is the same as the power source.
	An electrical component has failed.	A technician should inspect the display, cable, and circuit board. Look for a red light on the circuit board.
The system runs continuously.	The unit is not able to reach the set point.	Close all the port holes and hatches. Adjust the set point so it is not too low for cooling or too high for heating.
	The seawater temperature is too high for cooling or too low for heating.	Seawater temperature will directly affect the air conditioning unit's efficiency. This air conditioning unit can effectively cool your boat in water temperatures up to 90 °F (32 °C) and heat (if reverse-cycle option is installed) in water as low as 40 °F (4 °C).
	The optional inside air temperature sensor is not located properly.	<ul style="list-style-type: none"> Verify the display location with the criteria found in the installation section of this manual. Install an optional inside air temperature sensor if necessary. If an optional inside air temperature sensor is already installed in the air stream, ensure it does not touch anything warm (like the condenser coil).
	The de-icing feature is not enabled.	Enable de-icing in the parameters. If ice still forms immediately, revisit the above possible causes.  Ice on a fan coil can be removed quickly by running the unit in HEAT mode.
There is a lack of airflow.	The airflow is blocked or restricted.	<ul style="list-style-type: none"> Remove any obstructions in the return-air stream. Clean the return-air filter and grille. Check for crushed or restricted ducting. Ducting must be as straight, smooth, and taut as possible.
	The fan speed is set to manual low.	<ul style="list-style-type: none"> If the fan speed is set to manual low, raise the speed to a higher setting or set to automatic mode. Or, increase the minimum low speed in the program parameters.
	The fan coil may be iced.	Refer to "The fan coil is iced." in this table.
The fan coil is iced.	The humidity level is set too high.	Close the hatches and doors.
	The supply air is short-cycling.	<ul style="list-style-type: none"> Redirect the supply air so that is not blowing in or near the return-air stream. Seal any air leaks on the duct.
	The airflow is blocked or restricted	Refer to "There is a lack of airflow." in this table.
	The fan runs too slow.	Set the fan speed to automatic mode or increase the manual fan speed. Or, increase the minimum low speed in the program parameters.
	The system runs continuously.	Close hatches and doors, raise set point, turn on de-icing.

Problem	Possible causes	Recommended solution
The condenser coil is iced while in HEAT mode.	The seawater temperature is below 40 °F (4 °C).	<ul style="list-style-type: none"> Shut down the system to prevent damage to the condenser. Allow the coil to defrost.
The fan does not run or runs continuously.	The digital control is set for either fan cycling with compressor or for continuous fan operation.	<p>Change the fan operation to continuous fan operation or fan cycling with compressor.</p> <p>i When configured for auxiliary electric heat, the fan will stay on for four minutes after a heat cycle ends even if the fan is set to cycled operation.</p>
	The circuit board on the unit is defective. Typically, the compressor and pump are still running.	<p>Call for service to replace the board.</p> <p>i A shorted relay or triac may cause the fan to never shut off or never turn on. If the fan never shuts off, the fan may be set to 'continuous' on the display.</p>
The unit does not heat.	The unit does not have a heating cycle.	Most units have a reverse cycle to create heat, but some units may not have this function.
	The display is set to cool-only or auxiliary electric heat.	Change the parameters on the display or press the Mode button to activate heating or automatic. The auxiliary electric heat will not function if the display is set to auxiliary electric heat and the unit does not have an auxiliary electric heater added.
	The reversing valve is stuck.	<ul style="list-style-type: none"> Lightly press on the valve with a rubber mallet while the unit is in HEAT mode. Call a service technician if that does not correct the problem.
	The seawater temperature is too low.	Seawater temperature directly affects the unit's efficiency. For the unit to heat (if the reverse-cycle option is available), water temperatures must be 40 °F (4 °C) or higher.
	There is a loss of refrigerant gas.	<ul style="list-style-type: none"> Check the air conditioning unit for a refrigerant oil leak. Call for service.
	(For CW systems only) The chilled-water loop is inadequately heated, the chiller system is not in the proper mode of operation, or the auxiliary electric heater is disabled.	<ul style="list-style-type: none"> Be sure the chiller is in HEAT mode. If the air handler system is equipped with water-temperature sensors, check the water temperature at the digital control. If the water temperature is not at least 15 °F warmer for HEAT mode, the water valve will not open. If the air handler system is equipped with an auxiliary electric heater, ensure that the auxiliary electric heat is enabled.
The unit does not cool.	The display is set to heat-only.	Change the parameters on the display or press the Mode button to activate cool or automatic mode.
	The seawater temperature is too high.	Seawater temperature will directly affect the air conditioning unit's efficiency. This air conditioning unit can effectively cool your boat in water temperatures up to 90 °F (32 °C). The unit may still work at higher water temperatures, but not as efficiently.
	There is a loss of refrigerant gas.	<ul style="list-style-type: none"> Check the air conditioning unit for a refrigerant oil leak. Call for service.
	(For CW systems only) The chilled-water loop is inadequately cooled or the chiller system is not in the proper mode of operation.	<ul style="list-style-type: none"> Be sure the chiller is in COOL mode. If the air handler system is equipped with water-temperature sensors, check the water temperature at the digital control. If the water temperature is not at least 15 °F cooler for COOL mode, the water valve will not open.
The unit switches to heat while in COOL mode.	The de-icing feature is enabled due to the coil possibly icing up during long run times.	Reprogram the de-icing cycle under the parameter settings.

Problem	Possible causes	Recommended solution
The pump does not shut off.	The circuit board is shorted.	<ul style="list-style-type: none"> • Call service to verify if a relay on the circuit board is shorted or if the pump relay board is defective, if applicable. • Replace any board that is shorted.
	The pump parameter on the display is set for the pump to run continuously.	Change the parameter on the display so the pump cycles with the compressor.
The pump does not run.	A high-pressure fault may be present.	Refer to "A high pressure fault is present." in this table.
The compressor does not shut off.	A relay on the circuit board has shorted closed.	Call service to verify and replace the board.
The compressor does not run.	A relay on the circuit board has shorted open.	Call service to verify and replace the board.
	There is an open overload on the compressor.	<ul style="list-style-type: none"> • Call service to verify and repair. • If the overload on the compressor is internal, wait several hours for it to cool before testing.
A low-pressure fault is present.	The unit does not have a low-pressure switch, but the JP2 jumper on the circuit board has been removed or a parameter, if applicable, has been enabled on the display.	<ul style="list-style-type: none"> • If the unit does not have a low-pressure switch, ensure the JP2 jumper on the board is in place over both pins. • Disable the parameter, if applicable.
	The low-pressure switch is open due to low seawater and/or low return-air temperatures.	Try to restart the air conditioning unit. The optional low-pressure switch has a ten-minute shutdown time delay that may be in effect.
	The low-pressure switch is open due to a loss of refrigerant.	<ul style="list-style-type: none"> • Check the air conditioning unit for a refrigerant oil leak. • Call for service.
	The low-pressure switch is defective or a wire is loose.	<ul style="list-style-type: none"> • Contact a servicing dealer to test the low-pressure switch and to ensure the wires are properly connected and seated in the orange plug on the circuit board. • Ensure the orange plug is not installed backwards on the circuit board.

Problem	Possible causes	Recommended solution
A high pressure fault is present.	The seawater flow is obstructed. The condenser coil may be too hot to touch.	<ul style="list-style-type: none"> • Water should be flowing strongly out of the overflow. Be sure the seacock is open and water is flowing to the pump. • Clean the seawater strainer. • Check for obstructions at the speed scoop thru-hull inlet. • Check for a strong, steady flow from the overboard discharge.
	The high-pressure switch is open (in heating) due to improper airflow.	<ul style="list-style-type: none"> • Remove any obstructions in the return-air stream. • Clean the air filter and grille. • Check for crushed or restricted ducting. The ducting must be as straight, smooth, and as taut as possible. • If the problem persists, reprogram the low fan speed limit for maximum value. • Set the low fan limit to 75, and set the reverse fan speeds during HEAT mode by changing the reverse fan speed in Heat under general settings, or manually set the fan speed to high.
	The high-pressure switch is open (in heating) due to a high seawater temperature.	The system may cycle on high-pressure if the seawater temperature is above 55 °F (13 °C).
	The high-pressure switch is defective or a wire is loose.	<ul style="list-style-type: none"> • Contact a servicing dealer to test the high-pressure switch and to ensure the wires are properly connected and seated in the orange plug on the circuit board. • Ensure the orange plug is not installed backwards on the circuit board.
	The seawater pump may be air-locked.	<ul style="list-style-type: none"> • Ensure that the seawater plumbing is installed according to the guidelines in the Installation Manual included with the air conditioning unit. • Remove the hose from the pump discharge to purge air from the line.
	The seawater pump is not running.	<ul style="list-style-type: none"> • Water should be strongly flowing out of the overflow . • Ensure the pump is not damaged from being run dry. • Check if the pump is receiving voltage. • Check the pump circuit breaker or the relay board, if applicable.
A low-AC voltage fault is present.	The supply voltage is too low.	Use a multimeter to verify that constant, steady power is available to the unit.
	The voltage is improperly calibrated, if applicable.	<ul style="list-style-type: none"> • Use a multimeter to verify that the voltage reading to the unit matches the voltage calibration in the parameters. • Adjust the voltage calibration if necessary.

Problem	Possible causes	Recommended solution
<p>The air conditioning unit does not respond to the changes entered on the display.</p>	<p>The display is experiencing a power interruption, voltage frequency fluctuation, electromagnetic interference from other equipment, or similar power-related issue.</p>	<p>Perform a factory reset of the display:</p> <ol style="list-style-type: none"> 1. Turn the power off. 2. Disconnect the cable from the display. 3. Turn the power on, wait 20 seconds, and turn the power off. 4. Reconnect the cable to the display. 5. Turn the power on. <p> This will cause all the parameters to reset to the factory default settings.</p>
	<p>The circuit board is recognizing previously connected displays.</p>	
	<p>The display-cable plugs are not making contact (for example, the plugs are unplugged, dirty, bent, or have broken pins). The display may show '999' or '---' if unable to communicate with the unit.</p>	<ul style="list-style-type: none"> • With the power off at the circuit breaker, remove the connector and inspect it. • Clean the socket and the cable with electrical contact cleaner. • Work the cable in and out of the socket. If damaged, replace the connector or the display cable.
	<p>The display buttons do not function.</p>	<p>The display is locked. Unlock the display.</p>
	<p>The display and the circuit board are not compatible.</p>	<ul style="list-style-type: none"> • Ensure the compatibility between the circuit board and the display. Some older boards will not work with newer displays and some newer boards will not work with older displays. • If the rebooted circuit board and display unit continue to act oddly, replace the display cable.
<p>The display does not show the correct room temperature.</p>	<p>The display is showing a code for a faulty air sensor, typically because there is a failed: display built-in temperature sensor, optional inside air temperature sensor, or display cable.</p>	<ul style="list-style-type: none"> • Replace the optional inside air temperature sensor. • If using the display built-in temperature sensor, replace the display or add an optional inside air temperature sensor. • Install a different display cable. • Ensure that the damaged jack/socket in the display head or on the circuit board is not damaged.
	<p>The temperature displayed is too high.</p>	<ul style="list-style-type: none"> • If the temperature displayed is within 50 °F above the actual temperature, use calibration parameter 4 to adjust. • If the temperature displayed is hotter than 50 °F above the actual temperature, adjust the JP5 jumper on the unit's circuit board. • Refer to the "Alternate air temperature sensor note" in this table.
	<p>The temperature displayed is too low.</p>	<ul style="list-style-type: none"> • If the temperature displayed is within 50 °F below the actual temperature, use calibration parameter 4 to adjust. • If the temperature displayed is colder than 50 °F below the actual temperature, adjust the JP5 jumper on the unit's circuit board. • Refer to the "Alternate air temperature sensor note" in this table.
	<p>The temperature adjusts too quickly or still does not read correctly.</p>	<p>Relocate the display or the optional inside air temperature sensor. The supply air should not blow on or near a sensor. Locate the optional inside air temperature sensor in the return air stream, not physically touching any part of the unit.</p> <p> Optional inside air temperature sensor note: if the unit uses an optional inside air temperature sensor, it will be either an RJ11 4-pin 3,000 K sensor or an RJ12 6-pin 10,000 K sensor.</p> <p>If the 6-pin sensor is installed, the JP5 jumper must be removed from the board. If neither sensor is installed on the circuit board, the display reads from its own built-in sensor, if applicable.</p>
<p>A low pump-flow fault is present, if applicable.</p>	<p>The condenser coil is too hot.</p>	<p>Verify the unit receives water flow and the condenser is not fouled.</p>
	<p>The thermistor is damaged.</p>	<ul style="list-style-type: none"> • Unplug the water sensor if installed. • Install another thermistor if one is available.
	<p>There is a damaged jack/socket on the circuit board.</p>	<p>Visually check to verify the pins inside the socket are not bent or corroded. Repair or replace the circuit board if needed.</p>

Problem	Possible causes	Recommended solution
A filter reminder is presented.	The timer setting to clean or replace the filter has been reached.	Clean or replace the filter and reset the filter hours.

9 Disposal



Place the packaging material in the appropriate recycling waste bins, whenever possible. Consult a local recycling center or specialist dealer for details about how to dispose of the product in accordance with all applicable national and local regulations.

10 Warranty Information

LIMITED WARRANTY AVAILABLE AT WWW.DOMETIC.COM/WARRANTY.

IF YOU HAVE QUESTIONS, OR TO OBTAIN A COPY OF THE LIMITED WARRANTY FREE OF CHARGE, CONTACT:

DOMETIC CORPORATION
 MARINE CUSTOMER SUPPORT CENTER
 2000 NORTH ANDREWS AVENUE
 POMPANO BEACH, FLORIDA, USA 33069
 1-800-542-2477

dometic.com

**YOUR LOCAL
DEALER**

dometic.com/dealer

**YOUR LOCAL
SUPPORT**

dometic.com/contact

**YOUR LOCAL
SALES OFFICE**

dometic.com/sales-offices
