

DOMETIC

**RCD10.5ES, RCD10.5XES,
RCD10.5ET, RCD10.5XET**

WARNING



CAUTION

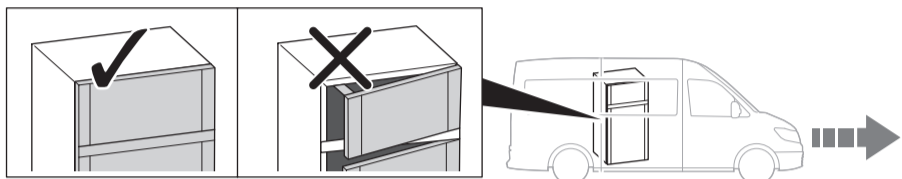

NOTICE

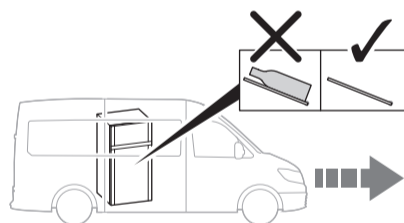
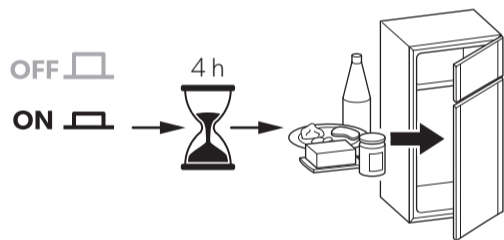
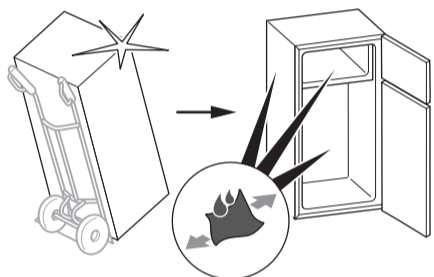

ON

1

RCD10.5ES, RCD10.5XES

RCD10.5ET, RCD10.5XET

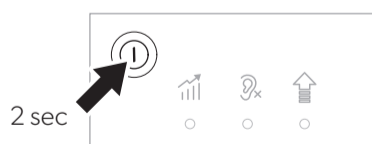

OFF

2

RCD10.5ES, RCD10.5XES

RCD10.5ET, RCD10.5XET

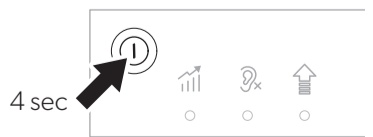

Operation

3

RCD10.5ES, RCD10.5XES

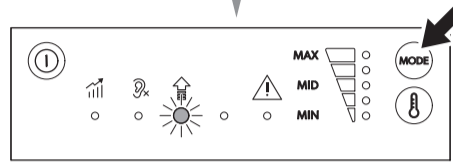
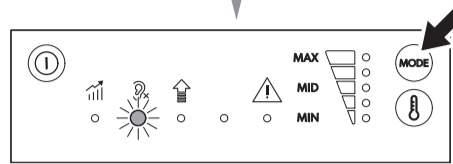

RCD10.5ET, RCD10.5XET

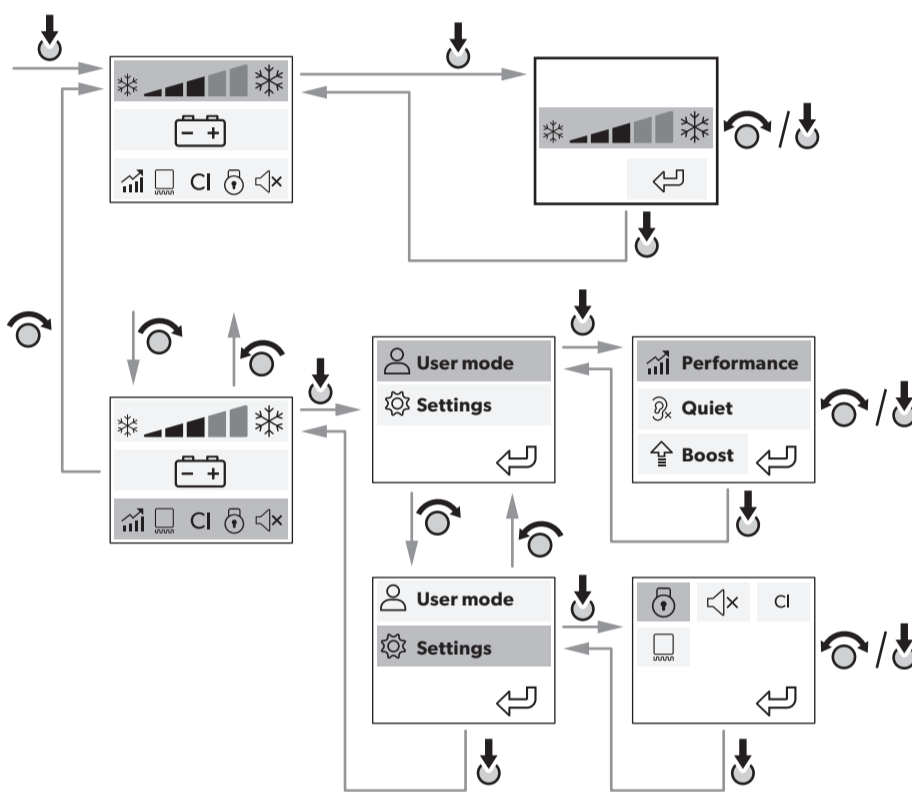

Cooling Capacity

4

RCD10.5ES, RCD10.5XES

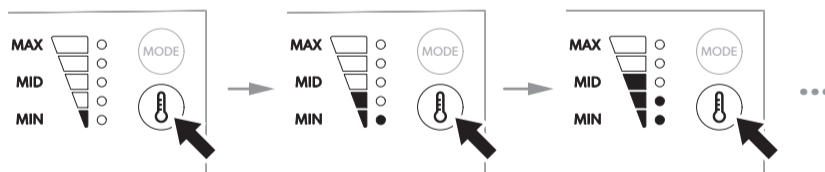

RCD10.5ET, RCD10.5XET

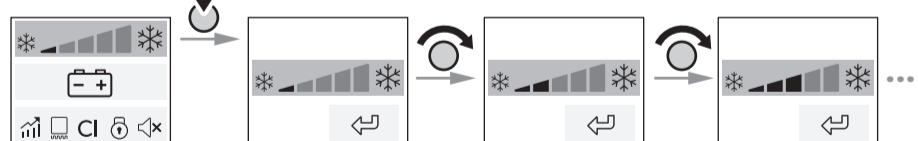

Shelves

5

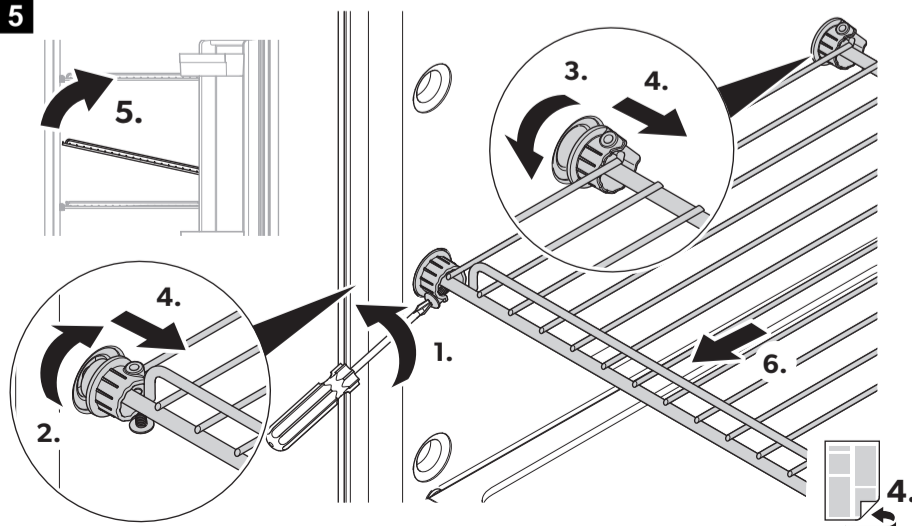

VG Fresh Base Out

6

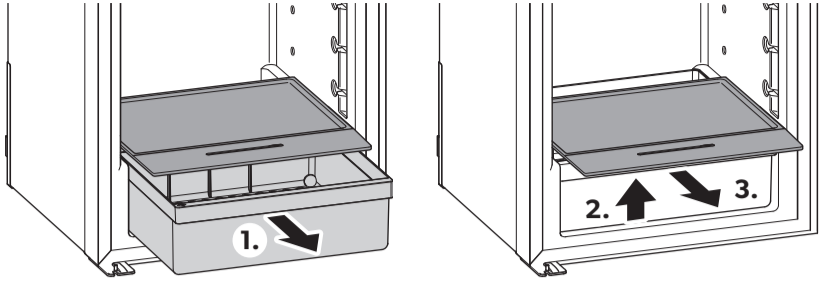

VG Fresh Base In

7

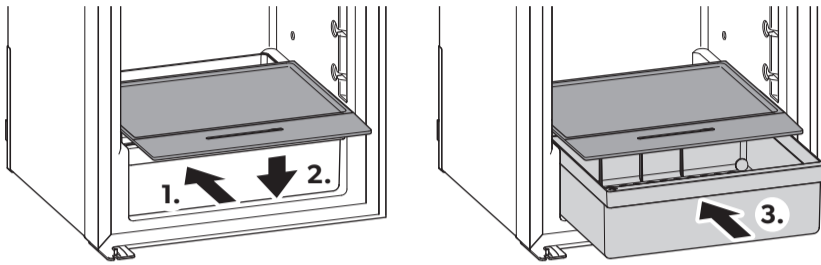

Defrost

8

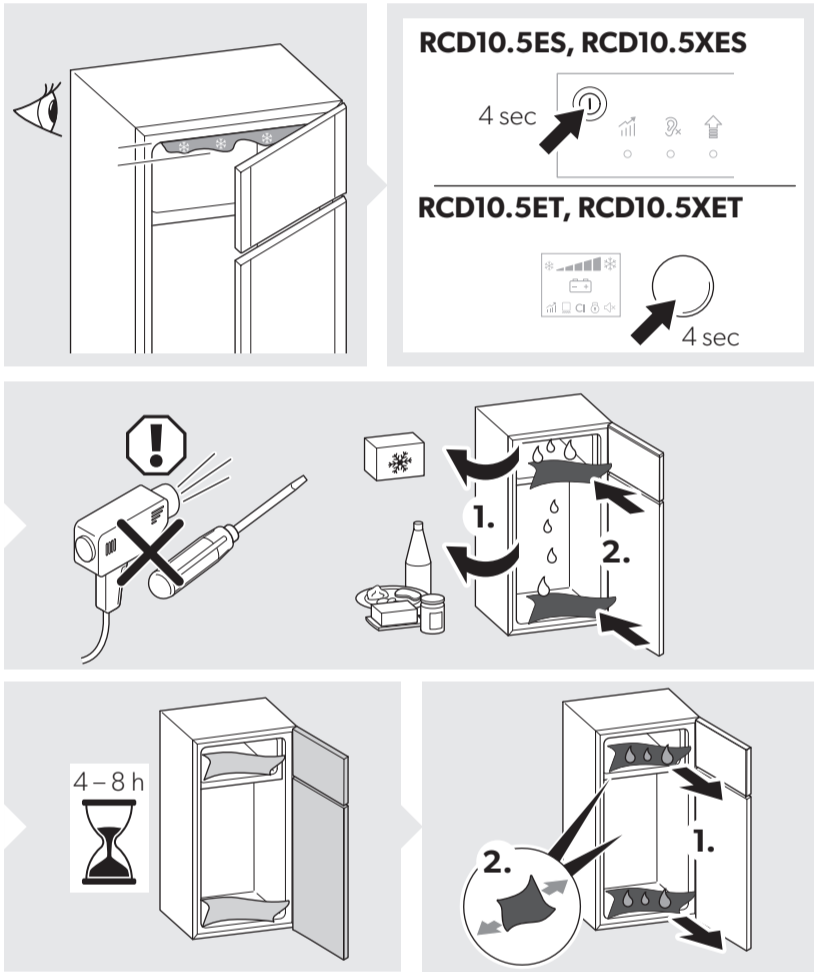

Winter

9

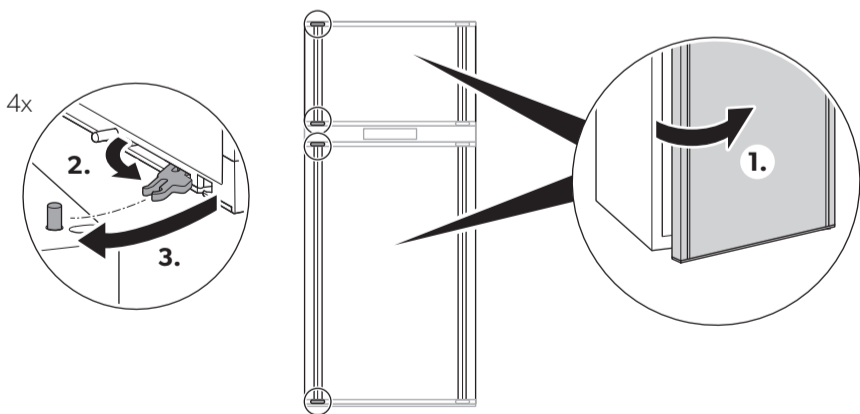

Releasing Door

10

RCD10.5ES, RCD10.5XES

